

RK3188-SOM AND RK3188-SOM-4GB

System-on-Module boards capable of Linux and Android boot

USER'S MANUAL

Document revision B, March 2017
Designed by OLIMEX Ltd, 2015



All boards produced by Olimex LTD are ROHS compliant

DISCLAIMER

© 2015 Olimex Ltd. Olimex®, logo and combinations thereof, are registered trademarks of Olimex Ltd. Other product names may be trademarks of others and the rights belong to their respective owners.

The information in this document is provided in connection with Olimex products. No license, express or implied or otherwise, to any intellectual property right is granted by this document or in connection with the sale of Olimex products.

The hardware designs of A20-SOM and A20-SOM-4GB development boards are considered intellectual property to Olimex. Hardware schematics are shared with the customers. However, the board layout files are considered copyright material and would not be shared.

The hardware design of RK3188-SOM-EVB development board is considered open source hardware. The source design files are published online and accessible by everyone.

The software is released under GPL.

It is possible that the pictures in this manual differ from the latest revision of the board.

The product described in this document is subject to continuous development and improvements. All particulars of the product and its use contained in this document are given by OLIMEX in good faith. However all warranties implied or expressed including but not limited to implied warranties of merchantability or fitness for purpose are excluded. This document is intended only to assist the reader in the use of the product. OLIMEX Ltd. shall not be liable for any loss or damage arising from the use of any information in this document or any error or omission in such information or any incorrect use of the product.

This evaluation board/kit is intended for use for engineering development, demonstration, or evaluation purposes only and is not considered by OLIMEX to be a finished end-product fit for general consumer use. Persons handling the product must have electronics training and observe good engineering practice standards. As such, the goods being provided are not intended to be complete in terms of required design-, marketing-, and/or manufacturing-related protective considerations, including product safety and environmental measures typically found in end products that incorporate such semiconductor components or circuit boards.

Olimex currently deals with a variety of customers for products, and therefore our arrangement with the user is not exclusive. Olimex assumes no liability for applications assistance, customer product design, software performance, or infringement of patents or services described herein.

THERE IS NO WARRANTY FOR THE DESIGN MATERIALS AND THE COMPONENTS USED TO CREATE RK3188-SOM, RK3188-SOM-4GB AND RK3188-SOM-EVB. THEY ARE CONSIDERED SUITABLE ONLY FOR RK3188-SOM, RK3188-SOM-4GB AND RK3188-SOM-EVB, RESPECTIVELY.

Table of Contents

<u>DISCLAIMER.....</u>	<u>2</u>
<u>CHAPTER 1: OVERVIEW.....</u>	<u>5</u>
<u>1. Introduction to the chapter.....</u>	<u>5</u>
<u>1.1 Introduction to SOM (System-On-a-Module).....</u>	<u>5</u>
<u>1.2 Target market of the board.....</u>	<u>6</u>
<u>1.3 Features of RK3188-SOM.....</u>	<u>6</u>
<u>1.4 Board variants.....</u>	<u>7</u>
<u>1.5 Board versions used in the manual.....</u>	<u>7</u>
<u>1.6 Document organization.....</u>	<u>7</u>
<u>CHAPTER 2: BOARD DESCRIPTION.....</u>	<u>8</u>
<u>2. Introduction to the chapter.....</u>	<u>8</u>
<u>2.1 Layout (top view).....</u>	<u>8</u>
<u>2.2 Layout (bottom view).....</u>	<u>9</u>
<u>CHAPTER 3: SETTING UP THE RK3188-SOM BOARD.....</u>	<u>10</u>
<u>3. Introduction to the chapter.....</u>	<u>10</u>
<u>3.1 Electrostatic and electrical polarity warnings.....</u>	<u>10</u>
<u>3.2 Requirements.....</u>	<u>10</u>
<u>3.3 Preparing the OS to boot.....</u>	<u>11</u>
<u>3.3.1 Should I boot from the microSD card or from the NAND memory?.....</u>	<u>11</u>
<u>3.3.2 Preparing a Debian microSD card.....</u>	<u>12</u>
<u>3.3.3 Uploading a Debian image to the NAND.....</u>	<u>12</u>
<u>3.4 Powering the board.....</u>	<u>14</u>
<u>3.4.1 Stand-alone powering.....</u>	<u>14</u>
<u>3.4.2 Mounted powering.....</u>	<u>15</u>
<u>3.5 Button functions.....</u>	<u>16</u>
<u>3.6 Interacting with the board.....</u>	<u>16</u>
<u>3.7 Expanding the Debian file system space.....</u>	<u>17</u>
<u>3.8 Changing the default image resolution.....</u>	<u>17</u>
<u>3.9 Connecting and calibrating a display.....</u>	<u>18</u>
<u>3.9.1 Android calibration.....</u>	<u>19</u>
<u>3.9.2 Debian calibration.....</u>	<u>20</u>
<u>3.10 Software support.....</u>	<u>20</u>
<u>CHAPTER 4: THE RK3188 PROCESSOR.....</u>	<u>21</u>
<u>4. Introduction to the chapter.....</u>	<u>21</u>
<u>4.1 The processor.....</u>	<u>21</u>
<u>4.2 Block diagram.....</u>	<u>22</u>
<u>CHAPTER 5: CONTROL CIRCUITY.....</u>	<u>23</u>
<u>5. Introduction to the chapter.....</u>	<u>23</u>
<u>5.1 Reset.....</u>	<u>23</u>
<u>5.2 Clocks.....</u>	<u>23</u>
<u>5.3 Power supply circuit.....</u>	<u>23</u>

CHAPTER 6: CONNECTORS AND PINOUT.....	24
6. Introduction to the chapter.....	24
6.1 Communication with RK3188-SOM in Linux.....	24
6.2 UART DEBUG header.....	24
6.3 MicroSD card connector.....	25
6.3.1 SD/MMC slot.....	26
6.4 GPIO connectors.....	27
6.4.1 GPIO-1 (General Purpose Input/Output) 40pin connector.....	28
6.4.2 GPIO-2 (General Purpose Input/Output) 40pin connector.....	29
6.4.3 GPIO-3 (General Purpose Input/Output) 40pin connector.....	30
6.4.4 GPIO-4 (General Purpose Input/Output) 40pin connector.....	31
6.5 LCD CON 40pin connector.....	32
6.6 Jumper description.....	33
6.7 Additional hardware components.....	33
CHAPTER 7: SCHEMATICS.....	34
7. Introduction to the chapter.....	34
7.1 Eagle schematic.....	34
7.2 General physical dimensions.....	34
CHAPTER 8: REVISION HISTORY AND SUPPORT.....	35
8. Introduction to the chapter.....	35
8.1 Document revision.....	35
8.2 Board revision.....	35
8.3 Useful web links.....	35
8.4 How to purchase?.....	37
8.5 Order codes.....	37
8.6 Frequently asked questions.....	38
8.7 Product support.....	40

CHAPTER 1: OVERVIEW

1. Introduction to the chapter

Thank you for choosing this single board computer from Olimex! This document provides a user's guide for the RK3188-SOM and RK3188-SOM-4GB boards. As an overview, this chapter gives the scope of this document and lists the board's features. The document's organization is then detailed.

The RK3188-SOM development board enables code development of applications running on the RK3188 microcontroller, manufactured by Rockchip from China.

The RK3188-SOM is typically used together with RK3188-SOM-EVB which features most of the peripherals and connectors needed for full evaluation and utilization of the RK3188 processor.

The hardware design of RK3188-SOM development board is considered intellectual property to Olimex. The hardware layout design files are considered copyright material and would not be distributed. The original schematics, however, are distributed in popular file format.

RK3188-SOM-EVB board is an open-source, open-hardware project and all documentation is available to the customer.

The software support for both boards is open-source and released under GPL license.

1.1 Introduction to SOM (System-On-a-Module)

OLIMEX System-on-Module (SOM) boards are powerful Linux-capable boards. They follow a low-cost modular design which allows rapid product development. Each of these boards has two parts – a main part which nests the processor, the memory and the power control unit and the peripheral part which contains the USB ports, the video output and most of the connectors. SOM designs are targeted at customers who want to apply custom modifications and own solutions based on a specific processor without having to deal with multi layer PCBs with controlled impedance and BGA assembly. This makes it possible to create simple boards (that might be manufactured by your local board manufacturer) containing only the peripherals you need with the dimensions and shape suitable for your specific solution.

Both the main part and the peripheral part of the SOM system have support in the official Android and Debian images distributed by Olimex and maintained by Olimex and the Linux community. These images are typically available at the wiki articles of the boards.

The peripheral part of the SOM design is considered Open Source HardWare (OSHW) and the customer has access to the board source files that we used to manufacture it. The part of the design that has the main microcontroller is considered proprietary design and design files would not be shared. If you are looking for open source design of the processors used please check the OLinuXino boards. OLinuXino board designs are fully open source but harder to implement in own solutions and require more of a hardware experience to do so. Nevertheless, OLinuXino boards are pretty good choice for evaluating the capabilities of the embedded processors.

1.2 Target market of the board

Using the RK3188-SOM as a stand-alone development board would be more suitable for users with some hardware experience or people already familiar with other single-board Linux boards and designs. As mentioned in the previous chapter the board is meant to be implemented in a hardware design.

It is highly recommended to use RK3188-SOM with RK3188-SOM-EVB initially, unless you have previous experience with SOM or OLinuXino boards manufactured by OLIMEX.

Note that in the OLIMEX web-shop the product named “RK3188-SOM-EVB” includes the main board named “RK3188-SOM-4GB”.

RK3188-SOM might be used altogether with RK3188-SOM-EVB. In that case, the board's target market widens drastically – the combination is suitable for embedded programming enthusiasts, Linux and Android gadget fans (they can just use the board as a media center or fully functional Linux-PC, for instance) and also professionals (since its low cost makes it very good solution for application-orientated embedded systems). The reason for this alteration is the additional hardware that RK3188-SOM-EVB – it provides direct HDMI output and easier ways to connect peripherals to the board. Generally, the processor's features become easier to access.

In which cases a **stand-alone** RK3188-SOM (without RK3188-SOM-EVB) board might not be suitable for you:

1. If you are a beginner with single-board Linux computers
2. If you are an OSHW purist
3. If you are looking for more straight-forward software development and you are not going to implement the RK3188-SOM in own hardware products

In the cases above, it might be a better idea to take a look at the OLinuXino boards (like A20-OLinuXino-MICRO or A20-OLiuXino-LIME2).

1.3 Features of RK3188-SOM

The RK3188-SOM board has the following set of features:

- Rockchip RK3188 quad core Cortex-A9 processor, each core typically running at 1.6GHz
- 1GB DDR3 memory
- 4GB NAND flash memory (available only in the 4GB version of the board)
- Debian Linux already loaded in the NAND (only in the 4GB version of the board)
- Integrated power management unit AC8846 PMU IC
- MicroSD card connector
- UART debug pins exposed
- 3 × user-programmable LEDs
- Power LED
- 3 × buttons – POWER, RESET, RECOVERY
- 5 connectors x 40 pin 0.05" step
- Dimensions: (3.2×1.8)" ~ (81×56)mm

1.4 Board variants

There are two major board variants named: RK3188-SOM and RK3188-SOM-4GB. The 4GB version has built-in NAND memory that allows the storage of an operating system without the need of a SD card. The 4GB version comes with already programmed and ready-to-use Debian Linux image.

Other SOM boards that might be compared to functionality are: the well-supported A20-SOM, and the new BeagleBone-inspired AM3352-SOM.

Another Olimex board with close characteristics is A13-SOM board. It is much cheaper and smaller. It heats less and consumes less power. However, it features a generation older processor and lesser amount of RAM memory, making it less desirable for heavy computations (for instance, high resolution video decoding and encoding). Yet, for simpler command-line tasks it might be the most suitable choice.

1.5 Board versions used in the manual

The documents follows the hardware layout of RK3188-SOM board revision C.

RK3188-SOM-EVB revision C peripheral board was used while writing this document.

Different board revisions might have different features or settings. It is possible that parts of this document do not apply to all board revisions.

1.6 Document organization

Each section in this document covers a separate topic, organized as follows:

- Chapter 1 is an overview of the board usage and features
- Chapter 2 contains the general board diagram and layout
- Chapter 3 provides a guide for quickly setting up the board and software notes
- Chapter 4 describes the component that is the heart of the board: the Rockchip RK3188 processor
- Chapter 5 is an explanation of the control circuitry associated with the microcontroller
- Chapter 6 covers the connector pinout, peripherals and jumper description
- Chapter 7 provides the schematics and the dimensions of the board
- Chapter 8 contains the revision history, useful links and support information

CHAPTER 2: BOARD DESCRIPTION

2. Introduction to the chapter

Here you get acquainted with the main parts of the board. Note the names used on the board might differ from the names used below to describe them. For the actual names check the RK3188-SOM board itself.

2.1 Layout (top view)

The picture below shows the top side of the board and highlights the most important parts:

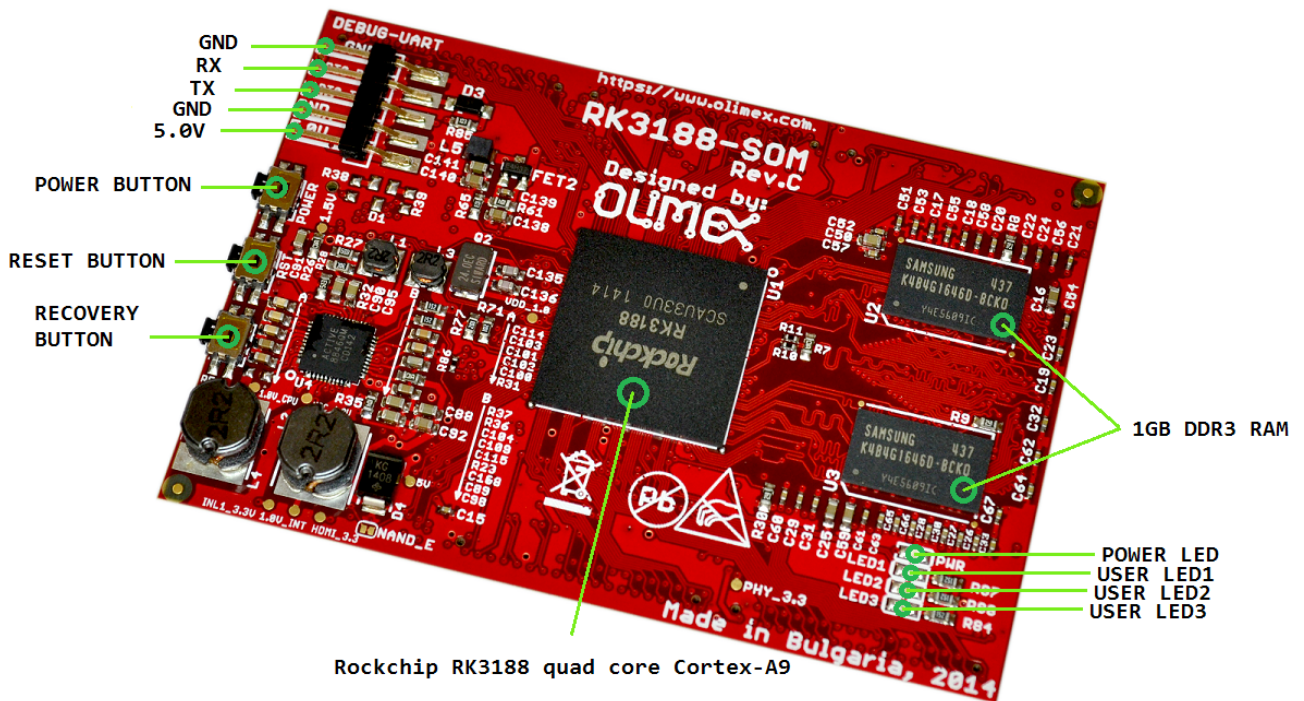

2.2 Layout (bottom view)

The picture below shows the bottom side of the board and highlights the most important parts:

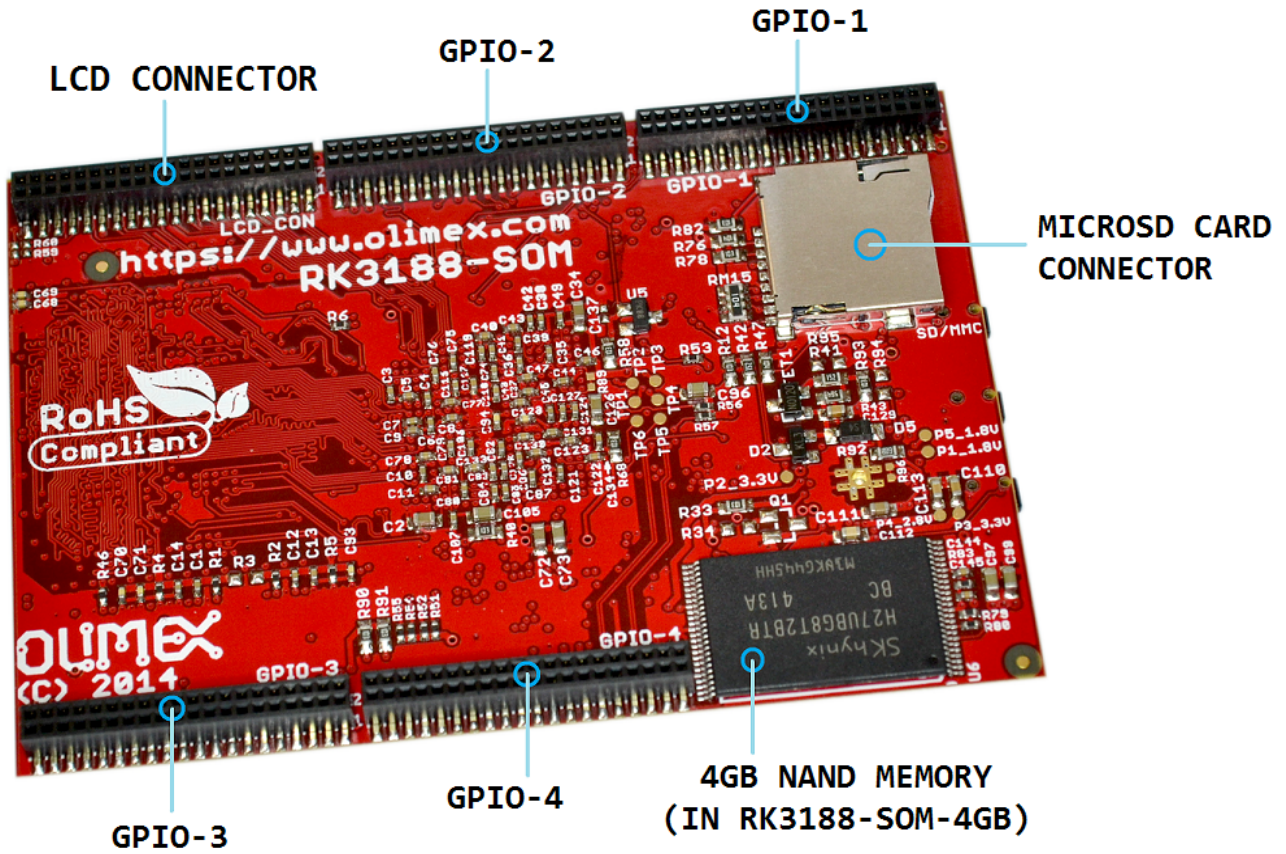

GPIO-1, GPIO-2, GPIO-3, GPIO-4, and LCD_CON are female connectors with 0.01" step. They are used to attach RK3188-SOM to RK3188-SOM-EVB (or to your custom shield of peripherals).

CHAPTER 3: SETTING UP THE RK3188-SOM BOARD

3. Introduction to the chapter

This section helps you set up the SOM development board for the first time. Please consider first the electrostatic warning to avoid damaging the board, then discover the hardware and software required to operate the board.

The procedure to power up the board is given, and a description of the default board behavior is detailed.

3.1 Electrostatic and electrical polarity warnings

RK3188-SOM boards are shipped in a protective anti-static package. The board must not be exposed to high electrostatic potentials. A grounding strap or similar protective device should be worn when handling the board. Avoid touching the component pins or any other metallic element.

Ensure that your development board gets attached to properly working hardware. If this is not possible please use isolators (like USB-ISO) to save your development board from potential over voltage.

If you connect other electrical devices to the SOM board make sure that they have equal electrical polarity. For example, when you connect a serial cable connected between a PC and the board's DEBUG port it is a good idea to have them both connected to the same electrical source (to the same utility power socket). In rare cases different polarity might cause hardware damage to the board.

3.2 Requirements

In order to set up the RK3188-SOM board optimally one or more additional items may be needed. They might be generally placed in two categories:

Required – items that are needed in order to achieve minimum functionality;

Recommended – items that is good to have in order to be able to interact with the most important of the features of the board;

Note that if RK3188-SOM is mounted on RK3188-SOM-EVB – the requirements would be different! The requirements below are for a stand-alone use of RK3188-SOM. Refer to RK3188-SOM-EVB's user's manual for adjusted requirements.

Required items:

- 5V-external power supply with proper connectors – RK3188-SOM has no power jack, only powering pins (+5V, GND)
- Output device – USB-SERIAL-CABLE-F + personal computer with serial terminal program – RK3188-SOM lacks other options for debugging – you would need a serial cable that can work at the CMOS levels of the board's signals
- SD card with compatible image – if you have the board version with NO additional NAND

memory you will need it to use one of the images available. If you decide to use Debian you would also need a card. Official Android and Debian images are available at the wiki article for the board.

Recommended items:

- **RK3188-SOM-EVB** – reference design of a 2-layer board for RK3188-SOM that adds HDMI, 100MB Ethernet, USB-OTG and 4x USB HS/FS/LS hosts, RTC with backup battery. The RK3188-SOM-EVB board also adapts the 0.05" step GPIO headers to 0.1" step headers so you can easily attach an LCD or UEXT module. Its hardware design is open source and available as Eagle CAD files, so everyone can modify and tailor it according to the specific needs.

Some of the above-suggested items can be purchased by Olimex, for instance:

USB-SERIAL-CABLE-F – female USB serial console cable – provides the easiest way of debugging

RK3188-SOM-DEBIAN-SD – a tested, class 10 micro SD card suitable for RK3188-SOM with the latest (by the time of leaving Olimex facilities) official Debian Linux release

3.3 Preparing the OS to boot

Currently, we provide only one official image for RK3188-SOM board – a Debian image that has to be downloaded to a microSD card. There is an extra Debian image suitable only for the NAND memory of RK3188-SOM-4GB. This means that if you have RK3188-SOM-4GB you can choose whether you want to boot from a microSD card or from the 4GB NAND memory.

Step-by-step instructions on how the images were prepared (and files required) are available at the wiki article here: <https://www.olimex.com/wiki/RK3188-SOM>

3.3.1 Should I boot from the microSD card or from the NAND memory?

Generally, booting from microSD card is faster and safer. However, in specific cases booting from NAND might be the better decision. Consider the below comparison when deciding where to boot from.

Using NAND is better than using microSD card when:

1. You are aiming for minimal power consumption;
2. there is no microSD card connector, no external connections are allowed or microSD card is not preferred storage medium;
3. for academic reasons.

Using NAND is worse than using microSD card because:

1. It is slower than a class 10 microSD card;
2. it is harder to make a backup;
3. in case of a problem with the file system – the device would not boot and the recovery (of your data) would be nearly impossible.

3.3.2 Preparing a Debian microSD card

In order to download an official Linux image to a microSD card under Windows you can use Win32 Disk Imager:

1. Download the latest official image suitable for a microSD card from the wiki article of the board
2. Download Win32 Disk Imager from [this link](#).
3. Insert card in your microSD card reader
4. Start program
5. Select the image
6. Click "write"

Under Linux you can write the image to the card with dd utility. This is how it can be done:

Let's say the name of the image is "debian_2g.img". It would be downloaded to the microSD card connected to a Linux machine using one of the following commands:

```
dd bs=4M oflag=sync if=debian_2g.img of=/dev/sdX
```

or

```
cp debian_2g.img /dev/sdX
```

where /dev/sdX is the uSD card as listed by the Linux.

3.3.3 Uploading a Debian image to the NAND

RK3188-SOM-4GB comes with Debian already loaded on the NAND memory. No need to perform this operation initially.

In case the image available on the NAND got corrupted or erased you can recover it the following way:

1. You need to download the software tools for your computer provided by Rockchip. If you use Windows download "Rockchip Batch Tool". If you use Linux use either rkflashkit or upgrade_tool. These are the tools that I recommend but there are a lot of tools available. If you are a Windows user get the Rockchip batch tool from here: [Rockchip Batch Tool](#)

For Windows:

2. Install the drivers that allows your computer to recognize the board (when the last is already set in bootloader mode) connected to it. The installer is called "Rockchip Driver Assistant" – download it here: [Rockchip Driver Assistant](#)

3. Download and extract the latest image suitable for the NAND from our wiki. The place in the wiki to look for a torrent of the latest image is this sub-chapter: [Debian for NAND memory](#)

4. Enter bootloader mode with the board to be able to establish connection between the board and the software provided by Rockchip. You would also need a mini USB cable. To enter bootloader mode you need to press and hold down the recovery button before powering the board (then connect

the board to the PC via the mini USB cable). After the board is powered you can release the button.

At this point, if the drivers from step 2 are properly installed you should see the device listed in "Windows Device Manager" as Rockusb Device:

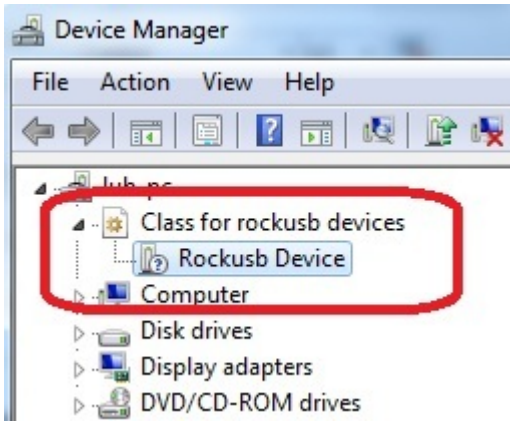

5. Start the tool for uploading the firmware and point it to the extracted image.

6. Click button "Upgrade" and wait till the upgrade and the verification are completed:

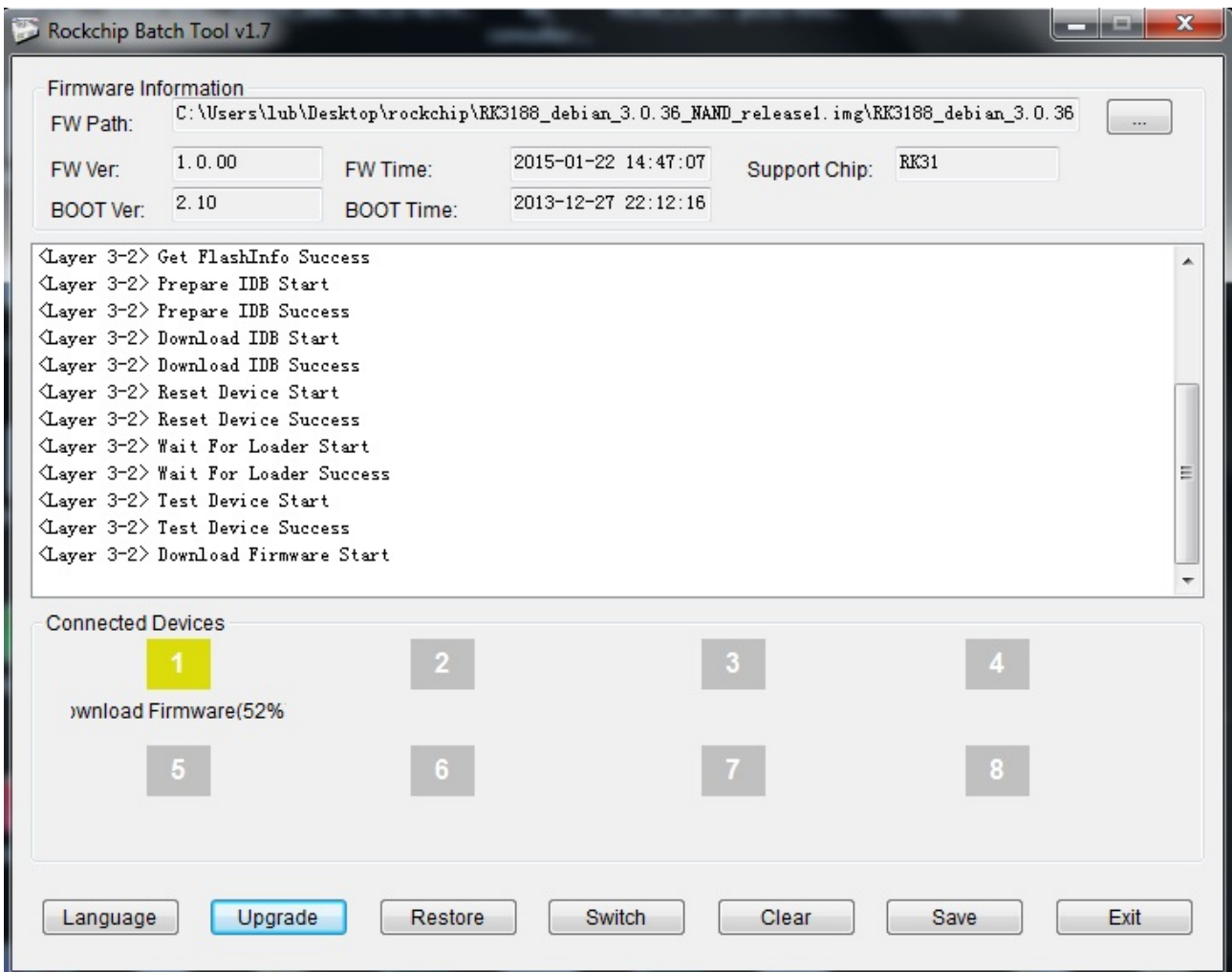

7. Test with a serial cable if the board boots fine. Test the commands shown below:

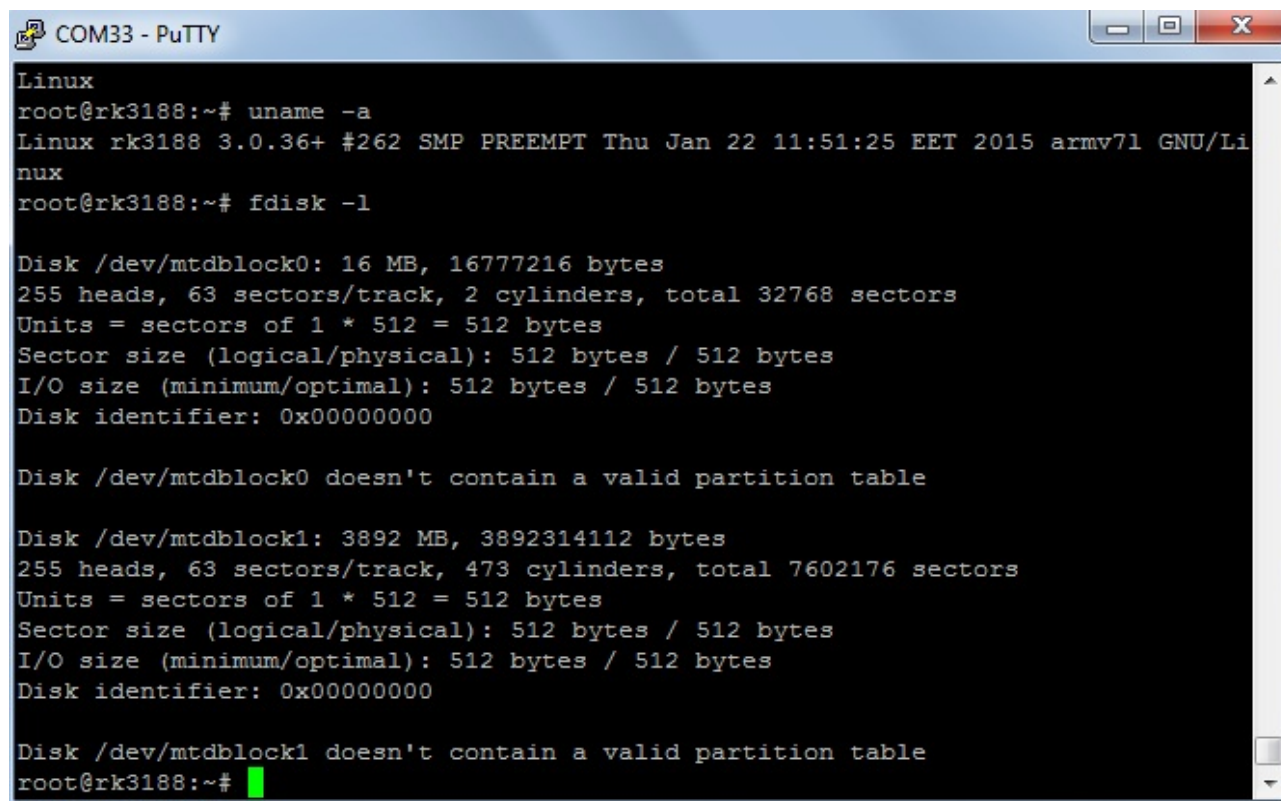

```
COM33 - PuTTY
Linux
root@rk3188:~# uname -a
Linux rk3188 3.0.36+ #262 SMP PREEMPT Thu Jan 22 11:51:25 EET 2015 armv7l GNU/Linux
root@rk3188:~# fdisk -l

Disk /dev/mtdblock0: 16 MB, 16777216 bytes
255 heads, 63 sectors/track, 2 cylinders, total 32768 sectors
Units = sectors of 1 * 512 = 512 bytes
Sector size (logical/physical): 512 bytes / 512 bytes
I/O size (minimum/optimal): 512 bytes / 512 bytes
Disk identifier: 0x00000000

Disk /dev/mtdblock0 doesn't contain a valid partition table

Disk /dev/mtdblock1: 3892 MB, 3892314112 bytes
255 heads, 63 sectors/track, 473 cylinders, total 7602176 sectors
Units = sectors of 1 * 512 = 512 bytes
Sector size (logical/physical): 512 bytes / 512 bytes
I/O size (minimum/optimal): 512 bytes / 512 bytes
Disk identifier: 0x00000000

Disk /dev/mtdblock1 doesn't contain a valid partition table
root@rk3188:~# █
```

3.4 Powering the board

The powering requirements of the RK3188-SOM are different depending on whether you use it in stand-alone mode or mounted atop RK3188-SOM-EVB. The sub-chapters below deal with both scenarios.

3.4.1 Stand-alone powering

If you use the board in stand-alone mode (e.g. it is neither attached to RK3188-SOM-EVB nor to any other board of peripherals) there are fewer options for powering it. Consider that you might need additional cables or connectors. You have the following options of powering the board:

1. provide +5V DC voltage to pin “5.0V” at the DEBUG-UART header; connect ground to pin “GND” of the same header
2. provide +5V DC voltage to either pin 1 of the LCD_CON header, or pin 1 of the GPIO-1 header; connect ground to pin 2 of the LCD_CON, or pin 2 of GPIO-1. **IMPORTANT** – provide power supply to only one of the mentioned pins, providing 5V to pin 1 of both headers simultaneously would lead to a short-circuit!
- *3. provide +5V driven by any USB to pin 1 of GPIO-4 (signal “+5V_OTG_PWR”); connect ground to pin 2 of GPIO-4

* Note that by default the +5V_OTG_PWR line is disconnected from the main processor. In case

you need to use it inspect the schematics for components D1, R38 and R39. It is just an optional power line that would require additional hardware components, should you choose to use it.

The default way of powering the board is using external power supply. In that case you would need to provide +5V DC at the “5.0V” pin of the DEBUG-UART connector. You would also need to connect the GND line of your supply to one of the GND pins of the same connector. The minimum power that your supply should be able to provide is 2.5W (equivalent of 0.5A of current at 5V of voltage). Note that there is no standard jack for the powering circuit but you might add your own DC power jack.

Do not provide AC voltage to the RK3188-SOM board! Do not provide more than 5V of voltage directly to the RK3188-SOM board! Providing 12V would instantly cause permanent hardware damage!

Sometimes when starting Android it is possible for the board to enter battery save mode even before booting fully. Especially, if you have turned off the board without quick boot mode enabled. In this case you should press the PWR button for at least 5 seconds which would allow the board to start. Furthermore, if the board has entered power-down state you can bring it back without restart using either REC or POWER button.

3.4.2 Mounted powering

Typically, RK3188-SOM gets evaluated when mounted atop RK3188-SOM-EVB. In this case the former is powered via the latter. The power line, altogether with a number of other important processor lines, is transferred via the 40-pin headers. RK3188-SOM receives power from RK3188-SOM-EVB, but what are the requirements to power RK3188-SOM-EVB?

You need to provide 6V to 16V DC voltage to the power jack (named PWR) of RK3188-SOM-EVB board. The DC barrel jack has 2.0mm inner pin and 6.3mm hole. More information about the exact component might be found here: <https://www.olimex.com/wiki/PWRJACK>

Do not provide AC voltage to the RK3188-SOM-EVB board! Do not provide more than 16V of voltage to the RK3188-SOM-EVB board!

The typical consumption of RK3188-SOM-EVB + RK3188-SOM is around 0.15A @ 10V but might reach peaks up to 0.25A @ 10V during initial boot. These values were measured without anything else connected to the board (e.g. no keyboard, no mouse, no LCD display, etc).

For the European customers, we also stock and sell basic power supply adapters compatible with the power jack.

The board can be powered by a personal computer using the USB_OTG connector. However, the USB standards limit the maximum power available at a personal computer's USB port. Thus, powering the board via the USB_OTG port is not recommended. Especially if you are using extra peripherals (like LCD display, keyboard, mouse, etc.).

Note that it is normal that when the board is powered some integrated circuits might appear hotter than others. This is perfectly normal for some electronic components – for instance – the voltage regulators and the main processor.

3.5 Button functions

The three buttons listed bellow are supported under both Android and Debian:

POWER – power up button – used to turn on the board (this button can not be used to power down the board)

REC – recovery button – used to wake up the board from sleep

RST – reset button – used for hardware reset of the board – before using it, please refer to the note below

It is always recommended to perform a soft “turn off” of the board. Then you are free to remove the power supply.

If you disconnect the power supply (either the USB or the power jack) before turning off the board you may corrupt your SD card. If your board has NAND memory you can corrupt the image located on the NAND memory.

3.6 Interacting with the board

The typical and recommended way of interacting with RK3188-SOM board is via a serial cable connected between the UART-DEBUG header and a personal computer. You would probably need a cable suitable for such a connection due to the fact that most personal computers lack a serial port nowadays. Even if you have serial port you should respect the CMOS levels of the board which are incompatible with the TTL levels of your computer. We distribute a ready-to-use plug-and-play cable – it is called USB-SERIAL-CABLE-F. Even if you already have such a cable or you decide to purchase it elsewhere it is advisable to check this product page for a reference:

<https://www.olimex.com/Products/Components/Cables/USB-Serial-Cable/USB-Serial-Cable-F/>

You need to connect the cable to the UART-DEBUG pins as follows: RX line to UART0-TX pin; TX line to UART0-RX pin; GND to GND. Make sure that the serial cable is connected to your personal computer and recognized properly after driver installation. After the hardware connection is established, open a terminal program on the serial (COM) port which the cable is associated with. The typical baud rate is 115200, the rest of the settings should be left as per default.

After everything else is set, you would need to power the board as explained in “3.3 Powering the board”.

In the command line interface of the official Debian images you are automatically logged as root. The default superuser username/password combination in the GUI (XFCE4) of the official images is: olimex/olimex.

If RK3188-SOM is attached to RK3188-SOM-EVB, in addition to the serial communication, you might also use one or more of the following mediums to interact with the board:

1. a monitor via HDMI connector
2. SSH with a remote computer via LAN connector
- 3 a display via LCD_CON connector

Refer to the RK3188-SOM-EVB's datasheet for more information on each connection.

Note that not all interface options are available for all images. Furthermore, some of the ways of interaction are not suitable for Android OS. The official Debian image should give you the most possible options of interfacing the board!

Using HDMI, LCD_CON or LAN might require additional configurations. Furthermore, it is possible to corrupt the output settings over those interfaces and, thus, lose the output. In such cases, you can always use the serial cable USB-SERIAL-CABLE-F as a reliable way to establish connection to the board.

3.7 Expanding the Debian file system space

The provided official Debian images have constant size but you may want to use a bigger microSD card.

In case you don't know how to expand the file system space you can use the built-in shell script for this task. This way you can take advantage of the whole volume of your microSD card.

Type in the command prompt:

```
./resize_sd.sh /dev/mmcblk0 1
```

After that you need to reboot the board with:

```
reboot
```

You can find the name given to the microSD card and its partitions using:

```
fdisk -l
```

3.8 Changing the default image resolution

The method for changing the output video resolutions varies whether you are using Android or Debian.

To ease the process of changing the resolution we have compiled a number of Android images for the Android users (with hard-coded video output settings). Alternatively, for Debian Linux users, we have provided a shell script that can be executed in order to set preferred video output and resolution.

For Android that you boot from the NAND memory you would need an image suitable for the specific resolution. Download locations to such images might be found at the wiki article for the RK3188 board here: <https://www.olimex.com/wiki/RK3188-SOM>.

For Linux Debian you would need to execute a shell script to be able to change the resolution. It is very good idea to use a serial cable for connection to the board from a personal computer since in this case you are not dependent on the current video output resolution (a cable like USB-SERIAL-CABLE-F). When the board boots type:

```
./change_display.sh
```

Then you would be asked for confirmation. Type:

```
yes
```

At this point you would be asked if you boot the Debian from a microSD card or from the NAND memory of the board. The script covers both cases. By default you would be booting from microSD so write "0".

The supported resolutions that you can select are:

HDMI OUTPUT	LCD OUTPUT
[0] HDMI 480p	[3] LCD 4.3 inch
[1] HDMI 720p	[4] LCD 7 inch
[2] HDMI 1080p	[5] LCD 10 inch

**HDMI 720p is the default video output resolution in the Debian image.*

Press the number that corresponds to the desired video output resolution.

At this point you would be asked if you wish to reboot the board. The video output changes would be applied after a reboot, so it is advised to reboot the board at this point.

The whole interface of the script is shown in the picture below:

```

COM33 - PuTTY
root@rk3188:~# ./change_dispay.sh
Warning! This script will overwrite your kernel with default one.
Continue? [yes/no]: yes

From where you boot?
[0] SD-card
[1] NAND flash
Enter [0/1]: 0
Selected: SD-card

Select new configuration:
[0] HDMI 480p
[1] HDMI 720p
[2] HDMI 1080p
[3] LCD 4.3 inch
[4] LCD 7 inch
[5] LCD 10 inch
Select [0..5]: 4
Selected: LCD 7 inch
23968+0 records in
23968+0 records out
12271616 bytes (12 MB) copied, 1.87905 s, 6.5 MB/s

Reboot? [yes/no]: yes

```

In case you need a custom video output resolution you would need to edit the kernel. There are no configuration files that can be easily edited to achieve the desired video output.

3.9 Connecting and calibrating a display

One of the ways to interact with the board is via an external display (with or without touchscreen component). However, there is only a 40-pin female connector LCD_CON with a 0.05" step.

Unlike other OLIMEX Allwinner boards, the RK3188-SOM lacks a row of pins that allows the user to connect a display out-of-the-box. The board's LCD_CON connector is female and has a smaller 0.05" step. This means that if you use a display made by OLIMEX, you would need additional 2×20 MALE-MALE 0.05" header to convert the female connector to male. The 0.05" headers are somehow hard to find so we sell them here: [0.05" step connectors](#). You would also need a compatible cable between the board and the display. The current generation of OLIMEX-made displays have both 0.1" and 0.05" step connectors. The cable used for connection depends on the specific board you are using and more specifically it depends on the pitch of the LCD connector of the board. We have two cables – both 40-pins ones but one for the bigger pitch (0.1") and the other for the smaller one (0.05"). Each of the displays listed in the table above has two connectors suitable for both cables:

CABLE-IDC40-15cm – 15cm long cable suitable for 0.1" step connectors – [Product page](#)

CABLE-40-40-10CM – 10cm long cable suitable for 0.05" step connectors – [Product page](#)

The displays recommended for the board at the moment of writing might be found in the table below:

Display name	Size of display in inches	Native resolution in pixels	Official Debian image support	Official Android image support	Link to product page
LCD-OLinuxino-4.3TS	4.3	480×272	Yes	No	Product page
LCD-OLinuxino-7	7	800×480	Yes	Yes	Product page
LCD-OLinuxino-7TS	7	800×480	Yes	Yes	Product page
LCD-OLinuxino-10	10.1	1024×600	Yes	Yes	Product page
LCD-OLinuxino-10TS	10.1	1024×600	Yes	Yes	Product page

The displays whose names contain “TS” - include a resistive touch screen component. Touchscreens are supported only if your board is mounted atop RK3188-SOM-EVB. The RK3188 processor lacks touchscreen support so in the design of RK3188-SOM-EVB we included external resistive touch screen controller AR1021.

3.9.1 Android calibration

Calibrating a display under Android is pretty straightforward from the Android application.

Important: initially the boards are calibrated for a specific display and resolution. If you re-write the image (no matter whether the SD card or the NAND memory) you might need to use a mouse to calibrate the display initially. It might be impossible to calibrate it only by using the touch component over the display.

3.9.2 Debian calibration

The command that allows calibrating in Debian Linux is:

```
ts_calibrate
```

The default Debian setup has video output settings set for HDMI 720p/60Hz. If you want to change some other LCD or HDMI resolution then you have to start script file in /root directory.

If the problem is under Debian Linux make sure you are properly logged in the FXCE4 interface! Else applying calibration would not happen for the current user – if you are calibrating from the X graphical interface make sure that you are logged as user “olimex” (if calibrating without the X, the user is “root”).

```
su olimex
```

enter the password: olimex

calibrate the touch screen and reboot the board

```
sudo reboot
```

3.10 Software support

At the moment, we provide ready-to-use Debian Linux images suitable for the NAND memory of the board or micro SD card. We also provide instructions and sources of these releases. These images might be downloaded for free and modified as the user wishes. The latest images and updates are featured at the wiki article of the device: <https://www.olimex.com/wiki/RK3188-SOM>.

We usually try to provide extra details and best experiences with our products at our wordpress page: <http://olimex.wordpress.com/>. Another useful place is the Olimex forums where a lot of people share their experience and advice: <https://www.olimex.com/forum/>.

The official images are a constant work-in-progress – newer releases are packed with better hardware support, newer kernels and extra features.

You are more than welcome to send or share your suggestions and ideas at our e-mail, the public forums or irc channel. We would attempt to help in almost every case. We listen to the feedback and if the majority of users suggest a software change or update we try to implement such. Customer feedback is very important for the overall state of the software support. However, do not expect full Linux or Android software support.

We can share our experience. We can give you full details for things we have tried. We can point you to a resource or a guide. We can give you general directions to solving a specific problem or places to look for more information. However, we won't install a piece of software for you or write custom program for you. We won't provide a specific software solution to a specific software problem.

CHAPTER 4: THE RK3188 PROCESSOR

4. Introduction to the chapter

In this chapter is located the information about the heart of RK3188 – its main processor. The information is a modified version of the datasheet provided by its manufacturers.

4.1 The processor

The main feature of the RK3188 processor is the sheer computing power that allows FullHD video playback. The 28nm die process used in the manufacturing keeps the power consumption very low. The graphical processing unit is also powerful and supported by the default software packages that come with the SOM boards. The software support for the features in the processor is at pretty good state thanks to the efforts of the community and Rockchip themselves.

A short list of features might be found below:

- CPU: Quad-core ARM Cortex-A9, up to 1.6GHz; 28nm low power process
- GPU: Mali-400MP4 GPU, up to 600MHz
- Supports OpenGL ES1.1/2.0, Open VG1.1
- High performance dedicated 2D processor
- 1080P multi format video decoding (H.265 and VP9)
- 1080P video encoding for H.264 and VP8
- Supports dual-panel display suitable for 2048×1536 resolution
- Supports dual camera
- Supports MLC NAND, eMMC
- Full RAM memory support, DDR3, DDR3L, LPDDR2
- Rich on peripheral support and connectivity options

More information about the features of the microprocessor can be found in either its documentation available at the Olimex GitHub repository:

<https://github.com/OLIMEX/OLINUXINO/tree/master/HARDWARE/RK3188-PDFs>

4.2 Block diagram

The block diagram is based on the RK3188's documentation.

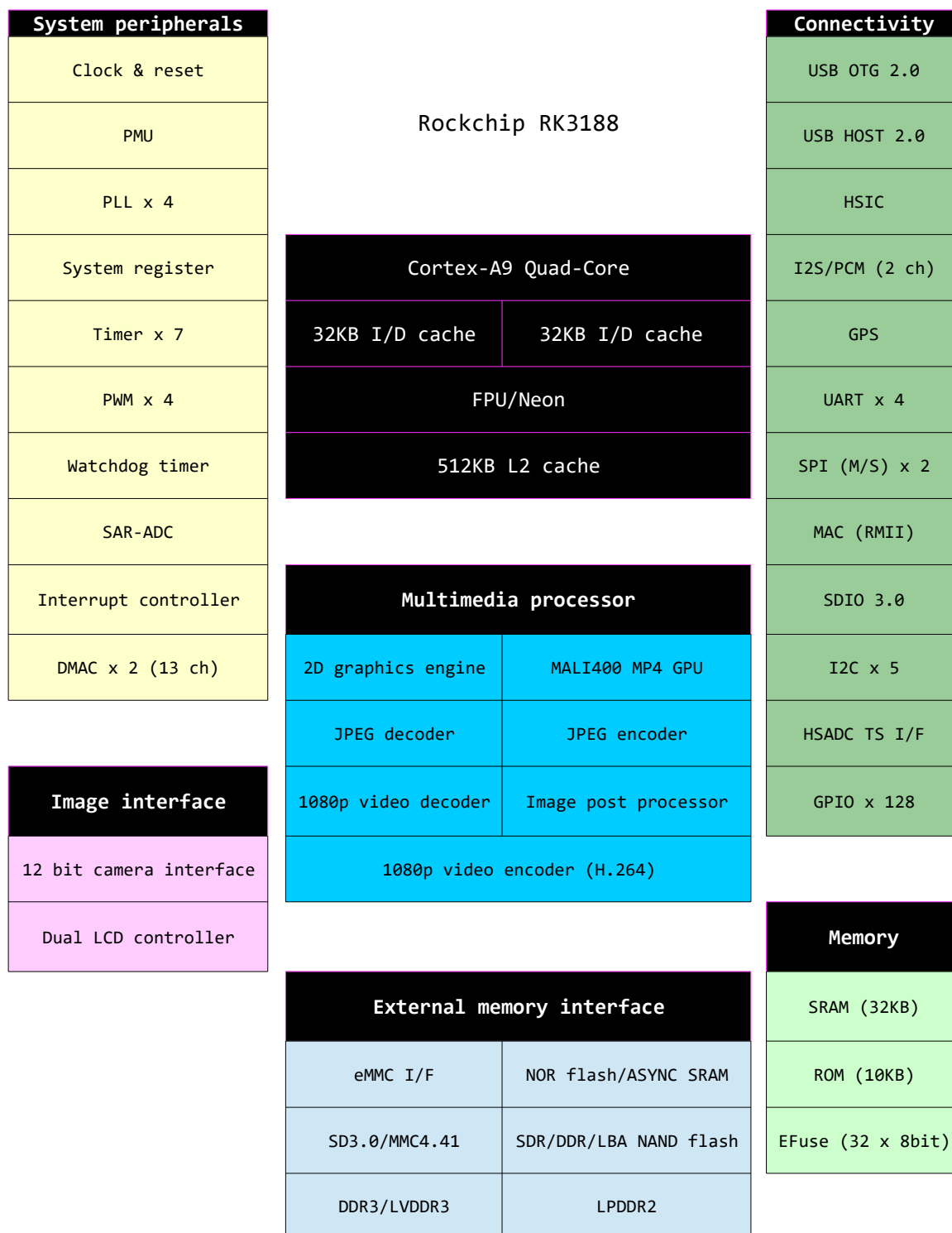

CHAPTER 5: CONTROL CIRCUITY

5. Introduction to the chapter

Here you can find information about reset circuit and quartz crystals locations, the power supply circuit is also briefly discussed.

5.1 Reset

The board has hardware reset controlled by the ACT8846 (in QFN48 package) power management unit. There is a hardware reset button placed on the board. The name of the button is “RST”.

It is a good practice to perform software reset of the board. Performing a hardware reset or power-cycling the board (reset by disconnecting and re-applying the main power supply) might lead to software corruption of the operating system of choice.

5.2 Clocks

24 MHz quartz crystal Q2 is found at pins AC8 and AB8 of the RK3188 processor.

5.3 Power supply circuit

The power supply is handled mainly by the ACT8846 advanced power management unit.

A stand-alone RK3188-SOM consumes between 0.05A and 0.10A when connected to a 5V voltage source (provided at UART_DEBUG pins “GND” and “5.0V”).

During heavy computational tasks the processor might consume up to 0.25A of current (tested at 5V of voltage with 'top d0').

The current consumed might have peaks as high as 0.35A during start-up when different on-board modules are initialized.

Make sure your power supply is capable of providing at least 0.5A of current at 5V of voltage (2.5W).

For more info on how to power the board refer to chapter “3.3 Powering the board”.

CHAPTER 6: CONNECTORS AND PINOUT

6. Introduction to the chapter

In this chapter are presented the connectors that can be found on the board all together with their pinout and notes about them. Jumpers functions are described. Notes and info on specific peripherals are presented. Notes regarding the interfaces are given.

6.1 Communication with RK3188-SOM in Linux

The direct access method to the Linux command interface is via the serial interface. You would need to use the pins of the UART_DEBUG and then use your favorite terminal program (puTTY, minicom, picocom, teraterm, etc) to access the command line interface of the debian the data/send commands. You can use USB-SERIAL-CABLE-F with the UART_DEBUG interface that allows you to connect to a personal computer with a free USB port.

If you decide to make your own cable you would need to consider that the levels at the board's connector UART_DEBUG are in CMOS level (3.3V) and you would need a convertor to bring them to the TTL level of your computer or cable! That is true for the RX and TX also!

It is highly recommended to have an USB-SERIAL-CABLE-F (or similar product) at hand when debugging – the video output is not always reliable and if you set wrong display settings you might be unable to recover the settings without a proper UART_DEBUG connection.

For more information please refer to chapter “3.5 Interacting with the board”.

6.2 UART_DEBUG header

The pins of the UART_DEBUG header might be used for serial communication between the board and a personal computer. They can also be used to power the whole RK3188-SOM board. In the case of a video output problem a cable might provide the needed feedback and greatly reduce the efforts needed to repair the board or to adjust the software setting.

Note that by default only UART_DEBUG is defined as a port suitable for serial debug. You can use our USB-SERIAL-CABLE-F for debugging.

Even when RK3188-SOM is mounted on RK3188-SOM-EVB the default debug port remains UART_DEBUG.

Consider the table on the next page when connecting the USB-SERIAL-CABLE-F to the board. Remember to refer to the wire color code of the cable. The RX line of the cable (GREEN wire) should go to TX line of the target board; the TX line of the cable (RED wire) should go to the RX line of the target board. The BLUE wire should go to a target's GND line.

The UART_DEBUG header can also be used to power a stand-alone RK3188-SOM. This is the recommended way of powering a standalone RK3188 board. The voltage input pin (+) is named “5.0V” and it is suitable for 5V DC external power supply unit. One of the two GND pins can be

used as ground (-). The required current may vary depending on the peripherals connected to the board. The power supply should be capable of providing at least 2.5W. For the powering, we are only interested in the 5.0V (+) pin and the GND (-) pin.

The signal names are printed near the pins, make sure to inspect the names before connecting the supply.

More info about the power supply can be found in chapter 5 of this manual.

UART_DEBUG			
Pin #	Printed name	Signal name	Processor pin
1	5.0V	+5V	-POWER CIRCUIT-
2	GND	GND	-POWER CIRCUIT-
3	UART0-TX	UART2-TX	P19
4	UART0-RX	UART2-RX	P20
5	GND	GND	-POWER CIRCUIT-

6.3 MicroSD card connector

The micro SD card slot is primarily used for booting the operating system.

The board works with micro SDHC cards up to 32GB of storage.

As a general precaution be careful with the SD cards you purchase. There is a big percentage of fake cards due to the low effort required to counterfeit popular brands and the big demand for SD cards worldwide. When in doubt – try the same operation with another card from another brand.

Olimex sells microSD cards with Linux or Android images, that have been tested – please refer to chapter “3.2 Requirements”. Of course, if you already have a large enough microSD card you can download the official Linux image from the wiki pages: <https://www.olimex.com/wiki/RK3188-SOM>.

When removing the card, please make sure that you release it from the connector by pushing and NOT by pulling the card directly (this can damage both the connector and the microSD card).

6.3.1 SD/MMC slot

The schematic related to the SD/MMC (microSD connector) is shown below.

SD/MMC slot is a microSD card slot connector, located on the top of the board.

This slot is typically used for booting the OS, due to the larger capacities of the microSD cards (compared to SD or MMC cards). It is suggested to have an SD card with a proper Linux/Android image especially if you have ordered a version of the board without NAND memory. It is recommended to use class 10 (10MByte/sec) card for faster read/write operations, since lower class cards (especially higher capacity ones) might slow down the whole system.

You can find the table with the pinout of the microSD connector on the next page.

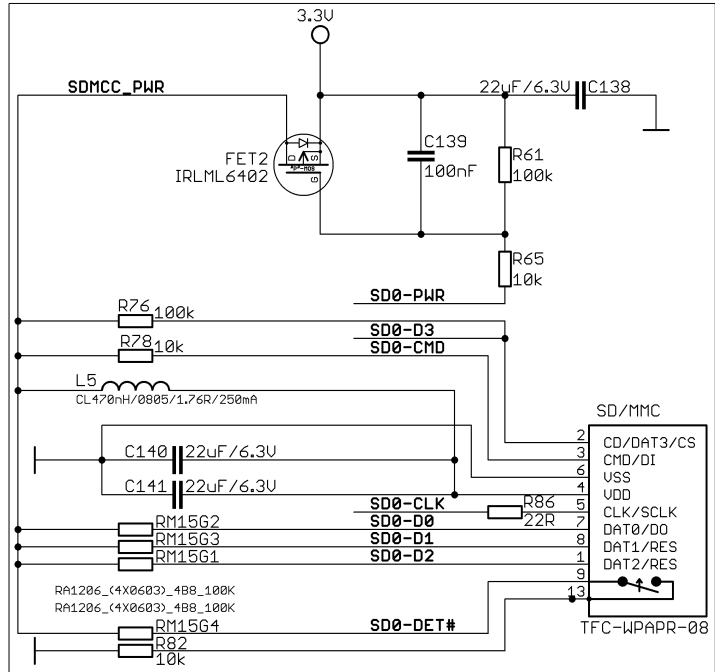

SD/MMC connector		
Pin #	Connector signal name	Wire name (processor pin)
1	DAT2/RES	SD0-D2 (V22)
2	CD/DAT3/CS	SD0-D3 (U20)
3	CMD/DI	SD0-CMD (T18)
4	VDD	SD_VCC (-POWER_CIRCUIT-)
5	CLK/SCLK	SD0-CLK (T19)
6	VSS	GND (-POWER_CIRCUIT-)
7	DAT0/DO	SD0-D0 (V20)
8	DAT1/RES	SD0-D1 (U22)
9	CARD DETECT(SYMBOL)	SD0-DET# (M21)
13	GND	GND (-POWER_CIRCUIT-)

6.4 GPIO connectors

There are 4 GPIO connectors located on the bottom side of RK3188-SOM. They ease the access to processors pins. These connectors (and connector LCD_CON) also provide a way to mount the board to a board of peripherals (like RK3188-SOM-EVB).

The only power line at the GPIO connectors that might be used as input is the one named '+5V' available at GPIO-1 and LCD_CON. The rest of the power signals are outputs and it would be incorrect to try to power the board from there.

To keep the form factor as small as possible the GPIO and LCD_CON connectors have 0.05" step.

IMPORTANT: the connectors are very fragile – if you attempt to disconnect the board by pulling only one side out it might break! Furthermore – you might bend the board's pins! Use pliers or other suitable object to disconnect the connectors carefully. OLIMEX sells additional and replacement male and female 0.05" (50 mil) step connectors.

Below you would find tables with the signal at each pin. To understand better what each processor pin does it might be a good idea to refer to the datasheet of the RK3188 processor. The schematic of the board of peripherals RK3188-SOM-EVB might also help you identify the main function of the pins.

You can also find the pinout of the GPIO and LCD connectors in a stand-alone document at the following link:

https://www.olimex.com/Products/SOM/RK3188/RK3188-SOM/resources/RK3188_SOM_GPIOs.pdf

6.4.1 GPIO-1 (General Purpose Input/Output) 40pin connector

GPIO-1 connector					
Pin#	Signal name	Processor pin	Pin#	Signal name	Processor pin
1	+5V	-POWER CIRCUIT-	2	GND	-POWER CIRCUIT-
3	GPIO1_C0/I2S0_CLK	Y13	4	GPIO1_C3/I2S0_LRCK_TX	Y14
5	GPIO1_C1/I2S0_SCLK	W16	6	GPIO1_C4/I2S0_SDI	AB13
7	GPIO1_C2/I2S0_LRCK_RX	AC19	8	GPIO0_B0	W8
9	GPIO0_A1	Y6	10	GPIO0_B1	AA7
11	GPIO0_A2	AA5	12	GPIO0_B2	AB6
13	GPIO0_A3/HOST_DRV	W7	14	GPIO0_B4/LED1	AC10
15	GPIO0_A5	W6	16	RTC_INT	AB10
17	GPIO0_A6	W11	18	GPIO0_B6/LED2	Y11
19	GPIO0_A7	AC7	20	GPIO0_B7	AA11
21	CIF_D0	AC2	22	CIF_HREF	AB2
23	CIF_D1	AC1	24	CIF_CLKI	V2
25	CIF_D2	AB3	26	CIF_CLKO	Y5
27	CIF_D3	W1	28	CIF_VSYNC	AA3
29	CIF_D4	W2	30	CIF_D15	AB1
31	CIF_D5	W3	32	CIF_D14	AA2
33	CIF_D6	V4	34	CIF_D13	Y2
35	CIF_D7	Y3	36	CIF_D12	Y1
37	CIF_D8	Y4	38	CIF_D11	AB4
39	CIF_D9	W4	40	CIF_D10	AA4

6.4.2 GPIO-2 (General Purpose Input/Output) 40pin connector

GPIO-2 connector					
Pin#	Signal name	Processor pin#	Pin#	Signal name	Processor pin#
1	3.3V	-POWER CIRCUIT-	2	GND	-POWER CIRCUIT-
3	I2C1_SCL	G19	4	I2C1_SDA	G20
5	GPIO1_C5/I2S0_SD00	AC13	6	RESET	AC5
7	GPIO2_B0/LCD1_D8	M3	8	GPIO2_D7/OTG_DRV	F22
9	GPIO2_B1/LCD1_D9	L3	10	GPIO2_D6/HDMI_INT	U4
11	GPIO2_B2/LCD1_D10	L2	12	GPIO2_D5	U3
13	GPIO2_B3/LCD1_D11	L1	14	GPIO2_D4	U2
15	GPIO2_B4/LCD1_D12	M2	16	GPIO2_D3/LCD1_VSYNC	U1
17	GPIO2_B6/LCD1_D14	N4	18	GPIO2_D2/LCD1_HSYNC	T3
19	GPIO2_B5/LCD1_D13	P4	20	GPIO2_D1/LCD1_DEN	T2
21	GPIO2_B7/LCD1_D15	N3	22	GPIO2_D0/LCD1_DCLK	T1
23	GPIO2_A0/LCD1_D0	K6	24	GPIO2_C7/LCD1_D23	T4
25	GPIO2_A0/LCD1_D1	K5	26	GPIO2_C6/LCD1_D22	R2
27	GPIO2_A0/LCD1_D2	L4	28	GPIO2_C5/LCD1_D21	R3
29	GPIO2_A0/LCD1_D3	K4	30	GPIO2_C4/LCD1_D20	P3
31	GPIO2_A0/LCD1_D4	K3	32	GPIO2_C3/LCD1_D19	P2
33	GPIO2_A0/LCD1_D5	K2	34	GPIO2_C2/LCD1_D18	P1
35	GPIO2_A0/LCD1_D6	L6	36	GPIO2_C1/LCD1_D17	N1
37	GPIO2_A0/LCD1_D7	L5	38	GPIO2_C0/LCD1_D16	N2
39	GPIO1_D6	AC11	40	GPIO1_D7	AA15

6.4.3 GPIO-3 (General Purpose Input/Output) 40pin connector

GPIO-3 connector					
Pin#	Signal name	Processor pin#	Pin#	Signal name	Processor pin#
1	VDD_HDMI	-POWER CIRCUIT-	2	VDD_PHY	-POWER CIRCUIT-
3	VCC_1.8	-POWER CIRCUIT-	4	GND	-POWER CIRCUIT-
5	ADC_IN0	H21	6	RTC_CLKOUT	AB5
7	ADC_IN2	H19	8	GPIO0_C0	W22
9	GPIO1_B2	U21	10	GPIO0_C1	W20
11	GPIO1_B3	T22	12	GPIO0_C2	W21
13	GPIO1_B4	T23	14	GPIO0_C3	Y23
15	GPIO1_B5	P21	16	GPIO0_C4	AB23
17	GPIO1_B6/SPDIF_TX	N20	18	GPIO0_C5	V21
19	GPIO1_B7	AB12	20	GPIO0_C6	V19
21	GPIO3_D0/RMII_MD	G23	22	GPIO0_C7	W23
23	GPIO3_D1/RMII_MDCLK	H22	24	GPIO3_B1	M22
25	GPIO3_D2/RMII_INT	H23	26	GPIO3_B2/HDMI_RST	F20
27	GPIO3_D5/PWM2	P22	28	GPIO3_C0/RMII_TXEN	L22
29	GPIO3_D6	P23	30	GPIO3_C1/RMII_TXD1	K22
31	GPIO1_D0	G22	32	GPIO3_C2/RMII_TXD0	K23
33	GPIO1_D1	G21	34	GPIO3_C3/RMII_RXD0	K19
35	GPIO1_D4/I2C2_SDA	F21	36	GPIO3_C4/RMII_RXD1	K20
37	GPIO1_D5/I2C2_SCL	E20	38	GPIO3_C5/RMII_CLK	K21
39	GPIO3_C7/RMII_CRS_DVALID	J22	40	GPIO3_C6/RMII_RX_ERR	J21

6.4.4 GPIO-4 (General Purpose Input/Output) 40pin connector

GPIO-4 connector					
Pin#	Signal name	Processor pin#	Pin#	Signal name	Processor pin#
1	+5V_OTG_PWR**	-POWER CIRCUIT-	2	GND	-POWER CIRCUIT-
3	OTG_ID	Y17	4	OTG_VBUS	AA17
5	NWP	Y18	6	OTG_DP	AC14
7	NRB0	W17	8	OTG_DM	AB14
9	NDQ0	AC20	10	HOST_DM	AB16
11	NDQ1	AB21	12	HOST_DP	AC16
13	NDQ2	AA21	14	NRE	AB19
15	NDQ3	Y22	16	NCLE	W18
17	NDQ4	AC22	18	NALE	U19
19	NDQ5	Y21	20	NWE	H19
21	NDQ6	AC23	22	NCE0	Y19
23	NDQ7	AB22	24	GPIO3_A0	N19
25	GPIO0_D0/FLASH_DQS	AB20	26	GPIO1_A7	AB12
27	GPIO0_D1/FLASH_CSN1	Y20	28	GPIO1_A6	AA13
29	GPIO0_D2/FLASH_CSN2	AA22	30	GPIO1_A5	Y16
31	GPIO0_D3/FLASH_CSN3	AA20	32	GPIO1_A4	AA12
33	GPIO0_D4	U23	34	GPIO1_A3	L23
35	GPIO0_D5	R21	36	GPIO1_A2	L21
37	GPIO0_D6	T21	38	GPIO1_A1	L19
39	GPIO0_D7	T20	40	GPIO1_A0	L20

6.5 LCD_CON 40pin connector

The LCD_CON pins are led out on a separate 40pin connector for the ease of connecting an LCD. We have tested the ability of the board to interact with such a display. They allow the user to attach additional hardware, check readings or perform hardware debug.

Important: you need additional adapter board and two different 40PIN ribbon cables to connect an Olimex display and the LCD_CON. The evaluation board RK3188-SOM-EVB provides a 0.1" step LCD connector which eases the hardware interfacing between the board and the display.

The LCD connector is suitable (but not plug-and-play due to the different pin-step) for a number of Olimex displays and touchscreen panels with different native resolution – the smallest available is the 4.3" one called **LCD-OLinuXino-4.3TS** with native screen resolution of 480×272, through the 7" one named **LCD-OLinuXino-7TS** with 800×480, to the 1024×600 10.1" **LCD-OLinuXino-10TS**.

Full list of recommended displays for the board might be found in chapter “3.7 Connecting and calibrating a display”.

LCD_CON connector					
Pin #	Signal name	Processor pin	Pin #	Signal name	Processor pin
1	+5V	-POWER CIRCUIT-	2	GND	-POWER CIRCUIT-
3	3.3V	-POWER CIRCUIT-	4	GND	-POWER CIRCUIT-
5	LCD0_D16	H5	6	LCD0_D17	H4
7	LCD0_D18	H3	8	LCD0_D19	H2
9	LCD0_D20	H1	10	LCD0_D21	K1
11	LCD0_D22	J3	12	LCD0_D23	J2
13	LCD0_D8	F3	14	LCD0_D9	F2
15	LCD0_D10	G5	16	LCD0_D11	G4
17	LCD0_D12	G3	18	LCD0_D13	G2
19	LCD0_D14	G1	20	LCD0_D15	H6
21	LCD0_D0	D0	22	LCD0_D1	E1
23	LCD0_D2	E2	24	LCD0_D3	E3
25	LCD0_D4	E4	26	LCD0_D5	G6
27	LCD0_D6	F5	28	LCD0_D7	F4
29	LCD0_HSYNC	A1	30	LCD0_VSYNC	B1
31	LCD0_CLK	D2	32	LCD0_DE	D3
33	GPI00_A6	NC/W11*	34	GPI00_A7	NC/AC7*
35	GPI03_D7/LCD0_PWRE	N22	36	GPI03_D4/PWM	R22
37	NC	NC	38	NC	NC
39	NC	NC	40	NC	NC

*The signals at pins 33 and 34 do not reach the processor by default due to the missing resistors R59 and R60. These signals can be used to change the scanning mode. These pins can be used to change the scanning mode (orientation) of an attached display. The default scanning mode is “up to down right to left”. Refer to the display datasheet for different modes. For example, refer to note 4 at page 7 of the datasheet of the 7 inch display used in OLIMEX A13-LCD7: <https://www.olimex.com/Products/OLinuXino/A13/A13-LCD7-TS/resources/S700-AT070TN92.pdf>

6.6 Jumper description

The board has a single SMT jumper. If you feel insecure of your soldering/cutting technique it is better not to try to adjust the jumper since it is possible to damage the board.

Board jumpers			
Jumper name	Type	Default position	Function
NAND_E	SMT	Either CLOSED or OPEN, depending whether the board has 4GB NAND MEMORY MODULE	Controls whether the NAND memory module is enabled or disabled. If the jumper is closed than the NAND memory is operational. By default it is set according to your board.

6.7 Additional hardware components

The components below are mounted on the RK3188-SOM but are not discussed above. They are listed here for completeness:

RST button – reset – used to reset the board

PWR button – power – used to power up the board

REC button – recovery – used to wake-up the board (from power down state)

1GB = 2×[4Gb (256 M x 16 bit) DDR3 SDRAM] – the exact memory used in the board revision mentioned is SAMSUG H5TQ2G63BFR

The DDR3 memory part name in the schematic might be outdated. We have used a number of different but fully compatible DDR3 memories due to supply unavailability. It is always recommended to check the exact memory name printed on the component itself.

4GB = 1×[32Gb (4096 M x 8 bit) NAND FLASH] – only available on the 4GB version of the board; the exact memory used in the board revision mentioned is HYNIX H27UBG8T2A

PWR_LED – power identification LED – turns on upon powering the board and remains on.

LED1, LED2, LED3 – user-programmable LEDs – using the default Debian Linux image, LED3 would start blinking – it gets started via a kernel module during start-up.

CHAPTER 7: SCHEMATICS

7. Introduction to the chapter

In this chapter is located information about the schematics describing logically and physically RK3188-SOM.

7.1 Eagle schematic

RK3188 schematics may be found in the OLIMEX's GitHub repository:

<https://github.com/OLIMEX/SOM/tree/master/RK3188>. You can download the whole repository as .zip without having a GitHub account.

The part of the design that has the main microcontroller is considered proprietary design and design files would not be shared.

If you are looking for a schematic of an older revision of the board and it isn't available at our web site you may request it by the support e-mail.

7.2 General physical dimensions

Note that all dimensions are in mils.

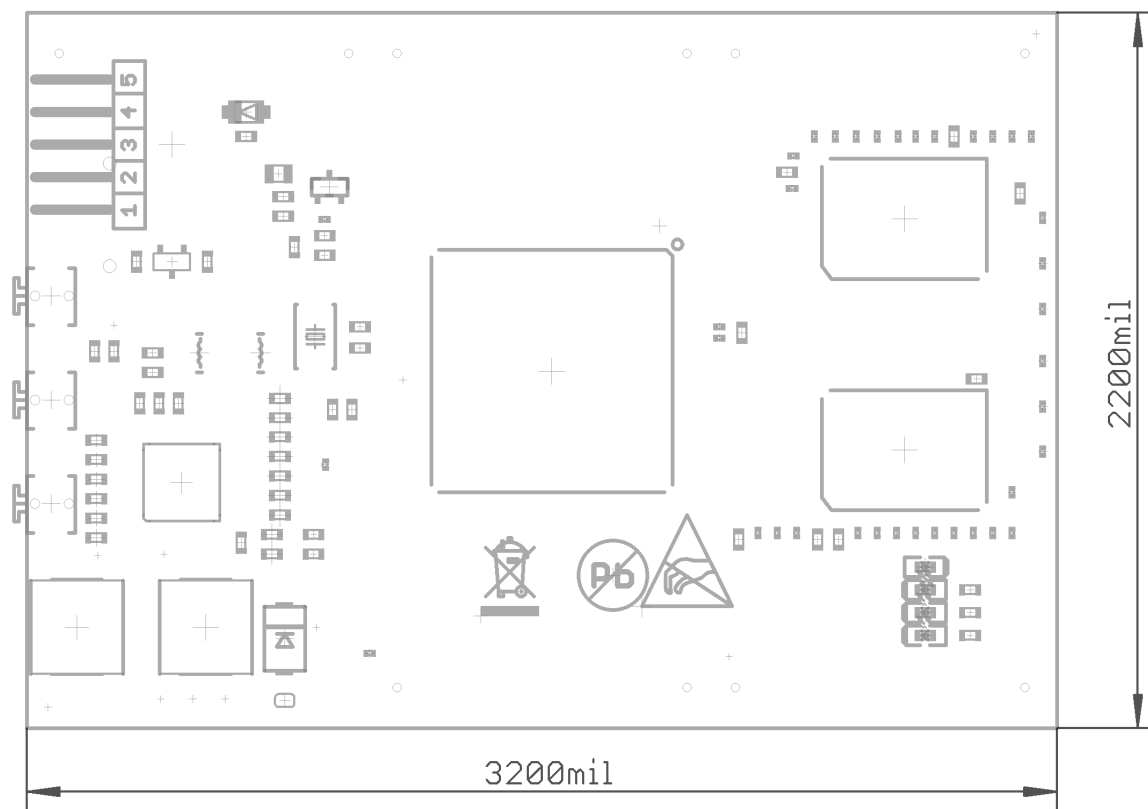

CHAPTER 8: REVISION HISTORY AND SUPPORT

8. Introduction to the chapter

In this chapter you will find the current and the previous version of the document you are reading. Also the web-page for your device is listed. Be sure to check it after a purchase for the latest available updates and examples.

8.1 Document revision

Document revision	Changes	Modified page
A, 27.03.15	Initial manual release	All
B, 02.03.17	Fixed information about power button	16

8.2 Board revision

Remember to check the schematics and the board design files to compare the differences.

Board revision	Notable changes
C	Initial release of the board

8.3 Useful web links

The web pages you can visit for more information about RK3188-SOM are:

<https://www.olimex.com/Products/SOM/RK3188/RK3188-SOM/> and
<https://www.olimex.com/Products/SOM/RK3188/RK3188-SOM-4GB/>.

Wiki article of the board: <https://www.olimex.com/wiki/RK3188-SOM>

A place for general questions, FAQ or friendly talk: <https://www.olimex.com/forum/>.

You can get the latest hardware updates at the GitHub page:

<https://github.com/OLIMEX/SOM/tree/master/RK3188>.

You may may join our IRC channel #olimex @ freenode.net (<http://webchat.freenode.net/?channels=olimex>).

RK3188-SOM-EVB's web page is here: <https://www.olimex.com/Products/SOM/RK3188/RK3188-SOM-EVB/>.

The user's manual of RK3188-SOM-EVB might be found here:

<https://www.olimex.com/Products/SOM/RK3188/RK3188-SOM-EVB-UM/resources/RK3188-SOM-UM.pdf>

8.4 How to purchase?

You can purchase directly from our online shop or from any of our distributors. Note that usually it might be faster and cheaper to purchase Olimex products from our distributors. List of confirmed Olimex LTD distributors and resellers: <https://www.olimex.com/Distributors>.

Please visit <https://www.olimex.com/> for more info.

8.5 Order codes

Short summary of the formal product names of the devices mentioned in this document:

RK3188-SOM – the target of this manual

RK3188-SOM-EVB – RK3188-SOM-4GB + a shield with all important peripherals (HDMI interface, LCD connector, 100Mb Ethernet with connector, USB-OTG, 4 x USB hosts, 0.1" GPIO connectors, etc)

USB-SERIAL-CABLE-F – USB serial console cable female

RK3188-SOM-DEBIAN-SD – a tested class 10 micro SD card with the latest (by the time of leaving the Olimex facilities) official Debian Linux release

LCD-OLINUXINO-4.3TS – low-cost 4.3" LCD display with touchscreen component – 480×272

LCD-OLINUXINO-7TS – low-cost 7" LCD display with optional touchscreen component – 800×480

LCD-OLINUXINO-10TS – low-cost 10" LCD display with optional touchscreen component – 1024×600

ALUMINIUM-HEATSINK-20×20×6MM – heatsink radiator for better processor heat dissipation

8.6 Frequently asked questions

Q: I powered my board and then nothing happened. What might be the problem?

A: This might be due to a number of reasons but it is recommended to try the following:

1. Download latest official Debian image from our wiki, and upload it to an SD card again. There are instructions how to do it in the other questions below. Try if the board works now.
2. Check if your power supply provides enough current, try with different/better power supply.
3. Check the USB hub you are using, plug the USB cable directly to the back of your personal computer, check the USB cable.
4. The board might enter sleep mode very fast (especially if the Android was turned off without the "Quick Boot" mode being ticked on). Try pressing or holding down the PWR button for a couple of seconds to wake it up.

Q: How do I write the Linux image to a micro SD card to use with my RK3188 board?

A: First visit the wiki article for the board and download the archive with the image. Then write the Linux image to a microSD card.

Under Windows you can use Win32 Disk Imager: <http://sourceforge.net/projects/win32diskimager/>

1. Download the latest official image suitable for a microSD card from the chapter above
2. Download Win32 Disk Imager from this link.
3. Insert card in your microSD card reader.
4. Launch the software.
5. Point the software to the image
6. Click "write"

Under Linux you can write the image image to the card with dd utility. This is how it can be done:

Let's say the name of the image is "debian_2g.img". It would be downloaded to the microSD card connected to a Linux machine using one of the following commands

```
dd bs=4M oflag=sync if=debian_2g.img of=/dev/sdX
```

or

```
cp debian_2g.img /dev/sdX
```

where X is the uSD card.

The tips above can also be used to prepare a microSD card with an Android image, suitable for a microSD card.

Q: How to edit board configurations and definitions in the official Debian Linux?

A: The Debian Linux support for boards using Rockchip processors is not as good as that of boards using Allwinner processors.

There are no configuration files for easier editing. You would need to rebuild the kernel.

Q: Is it possible to boot Debian from NAND? Do you provide such image?

A: Yes. Refer to chapter "3.3 Preparing the OS to boot". Read how to prepare the NAND image from scratch here: https://www.olimex.com/wiki/RK3188-SOM#Booting_from_NAND

Q: How to generate boot-able SD-card Debian Linux image for RK3188-SOM?

A: Build instructions and required files for the latest Debian images might be found at the wiki page of the board. The step-by-step instructions are available here:
https://www.olimex.com/wiki/RK3188-SOM#Building_Linux_for_RK3188-SOM

Q: How to detect and enable the Ethernet controller (if it is disabled by default)?

A: You can enable it by following these two steps:

1. To check under what name the LAN is associated write "ifconfig -a"
2. If, for example, it is under eth0 name, then write: "dhclient eth0"

This should enable the Ethernet and then SSH would also be available.

You can also enable auto detection of Ethernet on power-up by removing the comment #auto eth0 in /etc/network/interfaces in the Linux image.

8.7 Product support

For product support, hardware information and error reports mail to: support@olimex.com. All document or hardware feedback is welcome. Note that we are primarily a hardware company and our software support is limited. Please consider reading the paragraph below about the warranty of Olimex products.

All goods are checked before they are sent out. In the unlikely event that goods are faulty, they must be returned, to OLIMEX at the address listed on your order invoice.

OLIMEX will not accept goods that have clearly been used more than the amount needed to evaluate their functionality.

If the goods are found to be in working condition, and the lack of functionality is a result of lack of knowledge on the customers part, no refund will be made, but the goods will be returned to the user at their expense.

All returns must be authorized by an RMA Number. Email support@olimex.com for authorization number before shipping back any merchandise. Please include your name, phone number and order number in your email request.

Returns for any unaffected development board, programmer, tools, and cables permitted within 7 days from the date of receipt of merchandise. After such time, all sales are considered final.

Returns of incorrect ordered items are allowed subject to a 10% restocking fee. What is unaffected? If you hooked it to power, you affected it. To be clear, this includes items that have been soldered to, or have had their firmware changed. Because of the nature of the products we deal with (prototyping electronic tools) we cannot allow returns of items that have been programmed, powered up, or otherwise changed post shipment from our warehouse.

All returned merchandise must be in its original mint and clean condition. Returns on damaged, scratched, programmed, burnt, or otherwise 'played with' merchandise will not be accepted.

All returns must include all the factory accessories which come with the item. This includes any In-Circuit-Serial-Programming cables, anti-static packing, boxes, etc.

With your return, enclose your PO#. Also include a brief letter of explanation of why the merchandise is being returned and state your request for either a refund or an exchange. Include the authorization number on this letter, and on the outside of the shipping box.

Please note: It is your responsibility to ensure that returned goods reach us. Please use a reliable form of shipping. If we do not receive your package we will not be held liable.

Shipping and handling charges are not refundable. We are not responsible for any shipping charges of merchandise being returned to us or returning working items to you.

The full text might be found at <https://www.olimex.com/wiki/GTC#Warranty> for future reference.