

(SHOWN ASSEMBLED)

DATE	REV	EON	APP'D. BY
1/31/06	A1	7462	JM
9-20-06	B0	7761	TRM
2-15-11	B1	9128	TRM
5-23-12	B2	9478	SMN

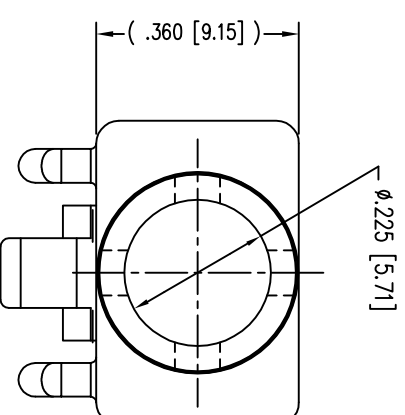
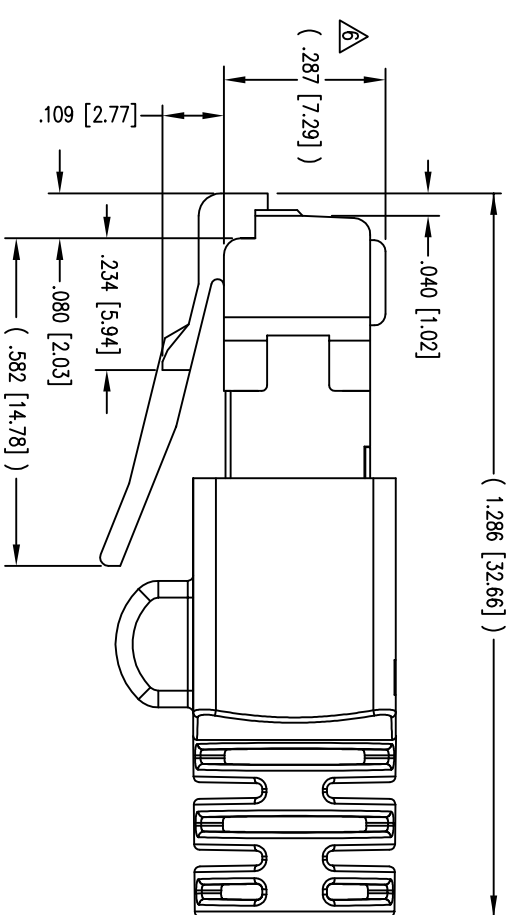
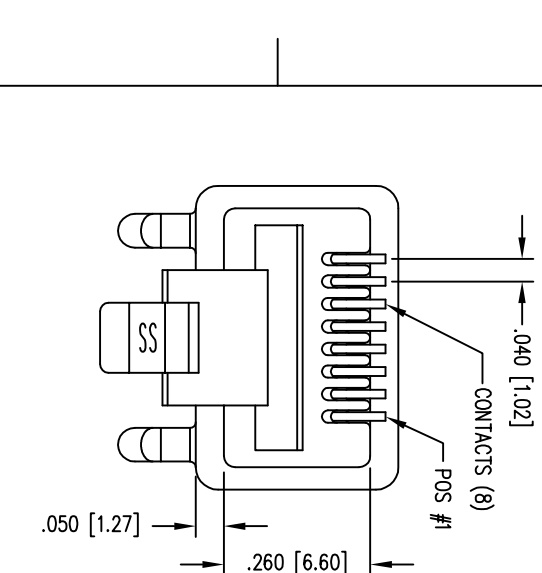

- NOTES:
- 1- PLUG KIT CONSISTS OF :
PRE-INSERTED PLUG HOUSING & SHIELD
MANAGEMENT BAR
FERRULE
HOUSING
 - 2- MATERIALS :
FRONT HOUSING PLASTIC : CLEAR POLYCARBONATE, UL 94-V0
MANAGEMENT BAR : CLEAR POLYCARBONATE, UL 94-V0
SHIELD : TIN PLATED BRASS
CONTACTS : PHOSPHOR BRONZE, SELECTIVE GOLD PLATING
FERRULE : NICKEL OR TIN PLATED BRASS
 - 3- CONTACTS TERMINATE STRANDED & SOLID CONDUCTORS UP TO .042 [1.07] OUTSIDE DIAMETER OF INSULATION.
 - 4- FOR PRODUCT SPECIFICATION SEE PRO26-01.
 - 5- DIMENSIONS AND TOLERANCES COMPLY WITH TIA-1096 STANDARD.
 - △ TERMINATED PLUG HEIGHT: .237 [6.02] ±.005 [0.13]
 - 7- DESIGNED FOR CATEGORY 5/5e APPLICATIONS.

BULK	50 MICRO-INCHES [1.27um]	943-SP-370808SM2-A496
PACKAGE	CONTACT PLATING IN MATING AREA	PART NUMBER

THIRD ANGLE PROJECTION

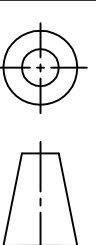

DO NOT SCALE DRAWING
DRAWING IS SUBJECT TO
CHANGE WITHOUT NOTICE

DIMENSIONS: INCHES [METRIC]
UNLESS OTHERWISE SPECIFIED
TOLERANCES ARE ±.005 [0.13]
ANGLES ARE ± 1°

SHEET NO. 1 OF 1

TITLE: SHIELDED CAT 5 PLUG, 8 X 8 SHIELDED PLUG

Bel Stewart Connector
11118 Susquehanna Trail South
Glen Rock, PA 17327-9199
(717) 235-7512 Fax: (717) 235-7954 <http://www.stewartconnector.com>

THIS DRAWING AND THE SUBJECT MATTER SHOWN THEREON ARE
CONFIDENTIAL, AND THE PROPRIETARY PROPERTY OF BEL STEWART CONNECTOR
AND SHALL NOT BE REPRODUCED, COPIED, OR USED IN ANY MANNER WITHOUT
PRIOR WRITTEN CONSENT OF BEL STEWART CONNECTOR. THIS PRODUCT
MAY BE PROTECTED BY ONE OR MORE OF THE FOLLOWING US PATENTS:
5628847 6402559 6409533 6524728
7753717 8033863
OTHER PATENTS MAY BE PENDING.

DRN BY:	DATE	APP'D BY:	DATE	DWG NO.	REV.
DAB	11-11-02	JRC	11-13-02	CT370045	B2

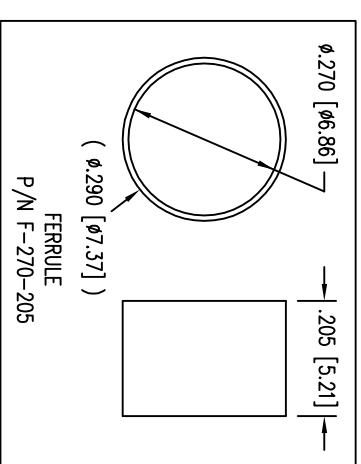
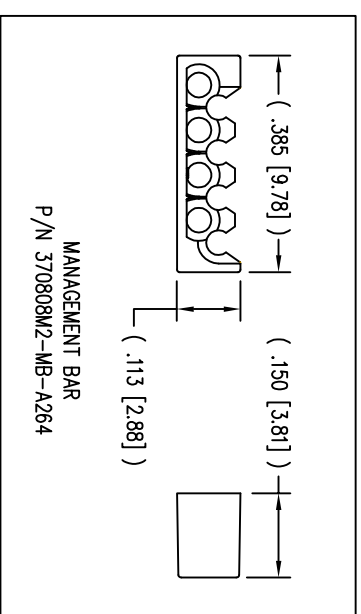
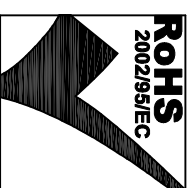

A

A

B

B