

SPECIFICATION

Part No. : **MA230.LBC.002**

Product Name : MA.230 Stream 3 in 1
 High Performance
 Adhesive Mount Combination Antenna
 GNSS - GPS/Glonass
 Cellular - LTE/HSPA/GSM/CDMA/UMTS
 Wi-Fi - 2.4/5 GHz

Description : IP67 Antenna
 GPS/ Glonass: 3M RG-174 SMA(M)
 1.8~5.5V/30dB

Cellular 2G/3G/4G: 3M Low Loss CFD-200 SMA(M)

Wi-Fi: 3M Low Loss CFD-200 RP-SMA(M)

Dimensions: 200.5*66.5*9mm
RoHS Compliant



1. Introduction

The Stream 3in1 MA230 GPS/Glonass, LTE Cellular 2G/3G/4G and Wi-Fi 2.4/5GHz antenna is a low profile, heavy-duty, fully IP67 waterproof external M2M antenna for use by RF professionals in telematics, transportation and remote monitoring applications. The Stream 3in1 is unique in the market as it combines the highest possible efficiency and peak gain for GPS/Glonass, Wi-Fi dual-band 2.4/5GHz and all cellular bands in 2G/3G/4G in a low profile compact format for mounting via high quality first tier automotive approved 3M adhesive foam.

Many module manufacturers specify peak gain limits for any antennas that are to be connected to that module. Those peak gain limits are based on free-space conditions. In practice, the peak gain of an antenna tested in free-space can degrade by at least 1 or 2dBi when put inside a device. So ideally you should go for a slightly higher peak gain antenna than mentioned on the module specification to compensate for this effect, giving you better performance.

Upon testing of any of our antennas with your device and a selection of appropriate layout, integration technique, or cable, Taoglas can make sure any of our antennas' peak gain will be below the peak gain limits. Taoglas can then issue a specification and/or report for the selected antenna in your device that will clearly show it complying with the peak gain limits, so you can be assured you are meeting regulatory requirements for that module.

For example, a module manufacturer may state that the antenna must have less than 2dBi peak gain, but you don't need to select an embedded antenna that has a peak gain of less than 2dBi in free-space. This will give you a less optimized solution. It is better to go for a slightly higher free-space peak gain of 3dBi or more if available. Once that antenna gets integrated into your device, performance will degrade below this 2dBi peak gain due to the effects of GND plane, surrounding components, and device housing. If you want to be absolutely sure, contact Taoglas and we will test. Choosing a Taoglas antenna with a higher peak gain than what is specified by the module manufacturer and enlisting our help will ensure you are getting the best performance possible without exceeding the peak gain limits.

GPS/Glonass

The patent pending design incorporates internally a custom Taoglas 35mm patch antenna on an extended integral ground-plane to deliver more than 3.5dBiC gain. A front-end SAW filter dramatically reduces radiated spurious emissions.



Cellular 2G/3G/4G

The extended ground-plane used with an innovative internal cellular PIFA also enables the unique wide-band 2G/3G/4G response to deliver the highest performance possible, at 3 metres cable length. Nothing else out there comes close in terms of consistency of efficiency and peak gain at all cellular bands, with 70%+ at the LTE 700MHz band, again including 3 metres of cable loss. High antenna efficiencies are absolutely critical in today's 3G and 4G systems to achieving targeted data-speeds and coverage.

Wi-Fi dual-band 2.4/5GHz

A powerful antenna gives maximum gain and coverage for common applications. 3dBi+ stable gain on both bands including cable loss means the antenna is ideal for high bandwidth applications.

All this is done while still maintaining 20dB isolation between antennas. The Stream uses shielded PTFE dielectric ultra low-loss cables that maintain low attenuation at all frequency bands, and high noise rejection, with an average loss of only 0.3dB per meter (0.1dB per foot), compared to 0.7dB for RG58 and 1.2dB for RG174. Because of this, the Stream maximizes chances of passing PTCRB and network approvals first time. The Stream works best when attached to plastic or glass, but can also be used on metal if a minimum of 40mm foam spacing is added.

2. Antenna Specification

Performance Specifications			
Items	GPS-GLONASS Antenna	Cellular Antenna	Wi-Fi Antenna
Features	High performance GPS/Glonass 35*35*4mm ceramic patch antenna	LTE – 700MHz	High performance dual-band Wi-Fi 2.4/5 GHz
		CDMA: 824-896 MHz	
		GSM: 880-960 MHz	
		DCS: 1710-1880 MHz	
		PCS: 1850-1990 MHz	
		3G: 1920-2170MHz	
Gain	1575.42MHz 1.92dBi typ @ Zenith 1602MHz 3.19dBi typ @ Zenith	Average: -3.03dBi at 700– 960MHz -4.34dBi at 1710 – 2170MHz	1.5dBi typ.@2450MHz 2.0dBi typ.@5000MHz
		Peak: 2.16dBi at 700 – 960MHz 0.42dBi at 1710 – 2170MHz	
VSWR	1.21 Max at 1575MHz 1.55Max at 1602MHz	3.3 Max. at 700- 960MHz 3.6 Max. at 1710- 1850MHz 2.2 Max. at 1880-2170MHz	2.30 Max at 2400MHz 1.08Max at 5000MHz
Impedance	50Ω	50Ω	50Ω
Efficiency		≧ 68% @ 700MHz, ≧ 72% @ 750MHz, ≧ 66% @ 824MHz, ≧ 56% @ 890MHz, ≧ 61% @ 880MHz, ≧ 53% @ 960MHz, ≧ 37% @1710MHz, ≧ 51% @1880MHz, ≧ 55% @1990MHz, ≧ 54% @2110MHz, ≧ 45% @2170MHz	≧ 40% @ 2450MHz ≧ 30% @ 5000MHz
Cable / Connector	3M RG-174 with SMA(M) Fully Customisable	3M CFD-200 with SMA(M) Fully customisable	3M CFD-200 with RP-SMA(M) Fully customisable
Housing	UV resistant ABS		
Adhesive Mount	3M 1600TB(196.57*62.57*1.25mm)		
Protection Class	IP-67		
Operation Temperature	-40°C to +85°C		
Storage Temperature	-40°C to +85°C		
Relative Humidity	20% to 95%		
Weight per unit	0.18kg		

LTE BANDS			
Band Number	LTE/LTE- Advanced /WCDMA/HSPA.HSPA+		
	Uplink	Downlink	Covered
1	UL: 1920 to 1980	DL: 2110 to 2170	✓
2	UL: 1850 to 1910	DL: 1930 to 1990	✓
3	UL: 1710 to 1785	DL: 1805 to 1880	✓
4	UL: 1710 to 1755	DL: 2110 to 2155	✓
5	UL: 824 to 849	DL: 869 to 894	✓
7	UL: 2500 to 2570	DL:2620 to 2690	✗
8	UL: 880 to 915	DL: 925 to 960	✓
9	UL: 1749.9 to 1784.9	DL: 1844.9 to 1879.9	✓
11	UL: 1427.9 to 1447.9	DL: 1475.9 to 1495.9	✗
12	UL: 699 to 716	DL: 729 to 746	✓
13	UL: 777 to 787	DL: 746 to 756	✓
14	UL: 788 to 798	DL: 758 to 768	✓
17	UL: 704 to 716	DL: 734 to 746 (LTE only)	✓
18	UL: 815 to 830	DL: 860 to 875 (LET only)	✓
19	UL: 830 to 845	DL: 875 to 890	✓
20	UL: 832 to 862	DL: 791 to 821	✓
21	UL: 1447.9 to 1462.9	DL: 1495.9 to 1510.9	✗
22	UL: 3410 to 3490	DL: 3510 to 3590	✗
23	UL:2000 to 2020	DL: 2180 to 2200 (LTE only)	✓
24	UL:1625.5 to 1660.5	DL: 1525 to 1559 (LTE only)	✗
25	UL: 1850 to 1915	DL: 1930 to 1995	✓
26	UL: 814 to 849	DL: 859 to 894	✓
27	UL: 807 to 824	DL: 852 to 869 (LTE only)	✓
28	UL: 703 to 748	DL: 758 to 803 (LTE only)	✓
29	UL: -	DL: 717 to 728 (LTE only)	✓
30	UL: 2305 to 2315	DL: 2350 to 2360 (LTE only)	✗
31	UL: 452.5 to 457.5	DL: 462.5 to 467.5 (LTE only)	✗
32	UL: -	DL: 1452 - 1496	✗
35		1850 to 1910	✓
38		2570 to 2620	✗
39		1880 to 1920	✓
40		2300 to 2400	✗
41		2496 to 2690	✗
42		3400 to 3600	✗
43		3600 to 3800	✗

3. GPS-GLONASS antenna

3.1. Return Loss

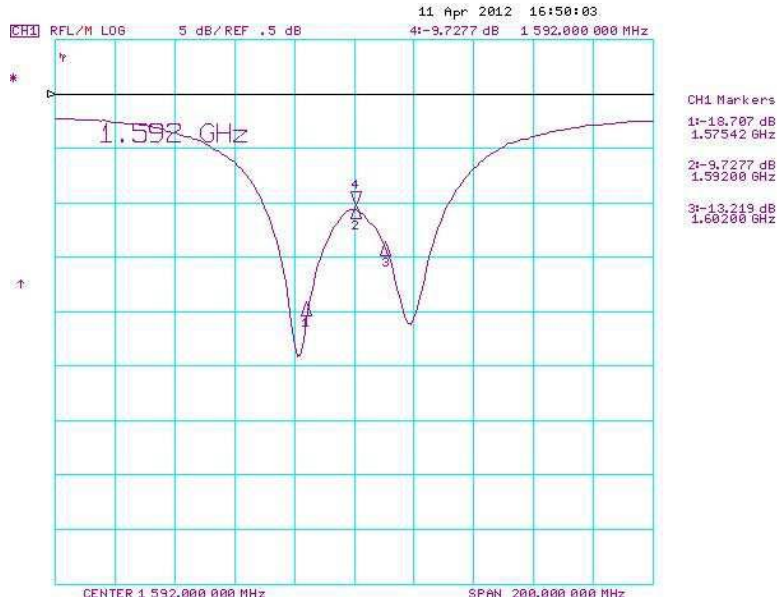

Return Loss : -18.70 dB @ 1575MHz

Return Loss : -13.21 dB @ 1602MHz

3.2. Smith Chart

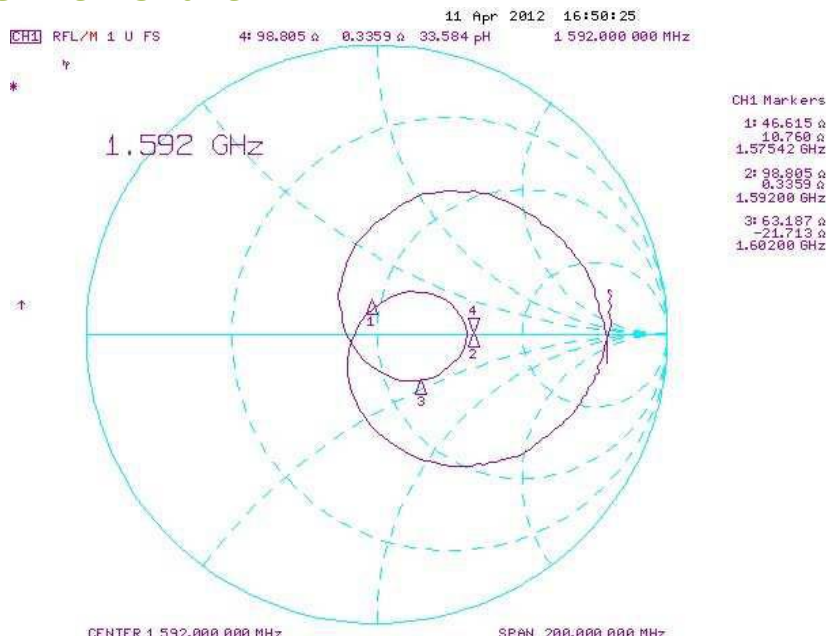

Impedance : 46.61 +j10.76 Ohm@ 1575MHz

Impedance : 63.18 -j21.73 Ohm@ 1602MHz

3.3. VSWR

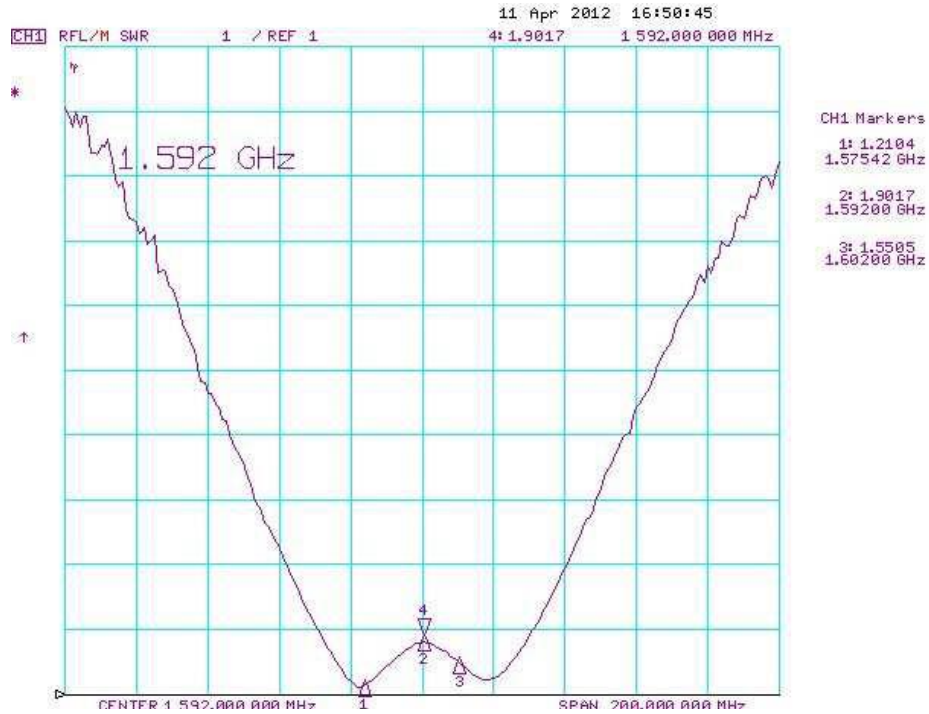

VSWR : 1.21 @ 1575MHz

VSWR : 1.55 @ 1602MHz

3.4. Radiation patterns

XZ-Plane

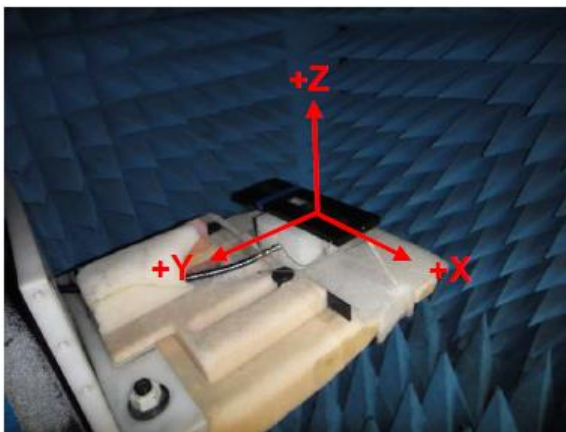

YZ-Plane

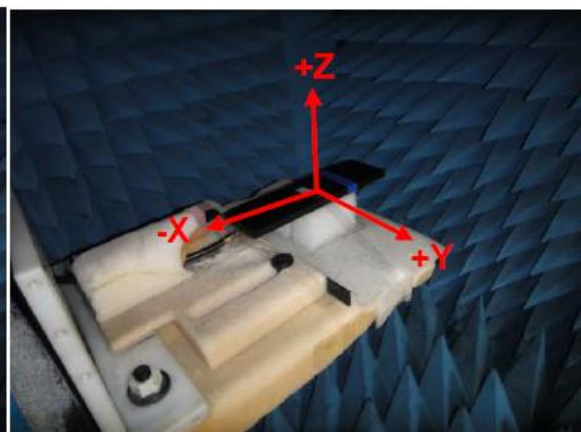

XZ Plane 1575.42MHz Horizontal & Vertical

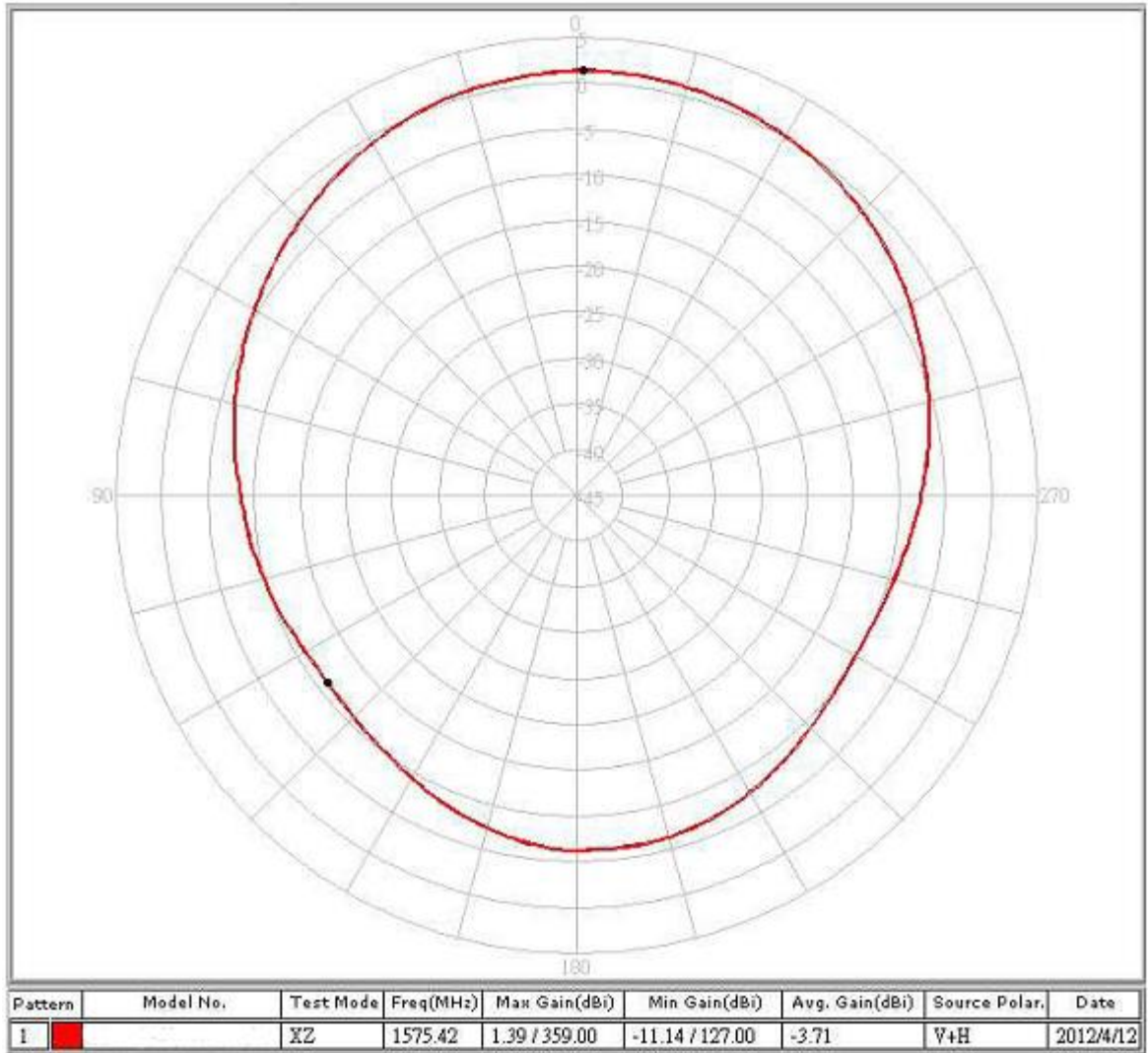

1575 MHz	Peak Gain	Zenith Gain
V+H	1.39	1.35

(dBi)

XZ Plane 1602MHz Horizontal & Vertical

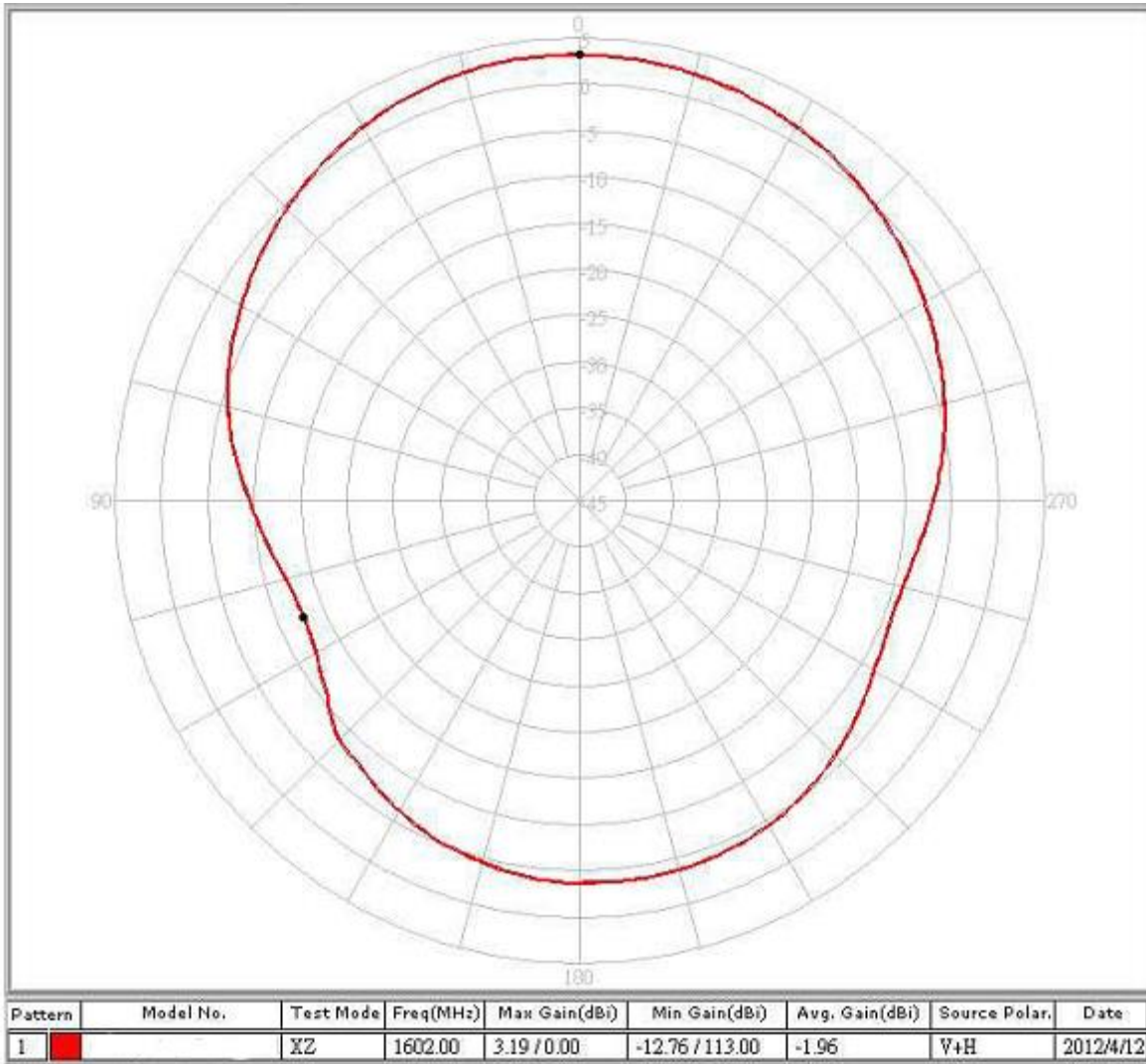

1602 MHz	Peak Gain	Zenith Gain
V+H	3.19	3.19

(dBi)

YZ Plane 1575.42MHz Horizontal & Vertical

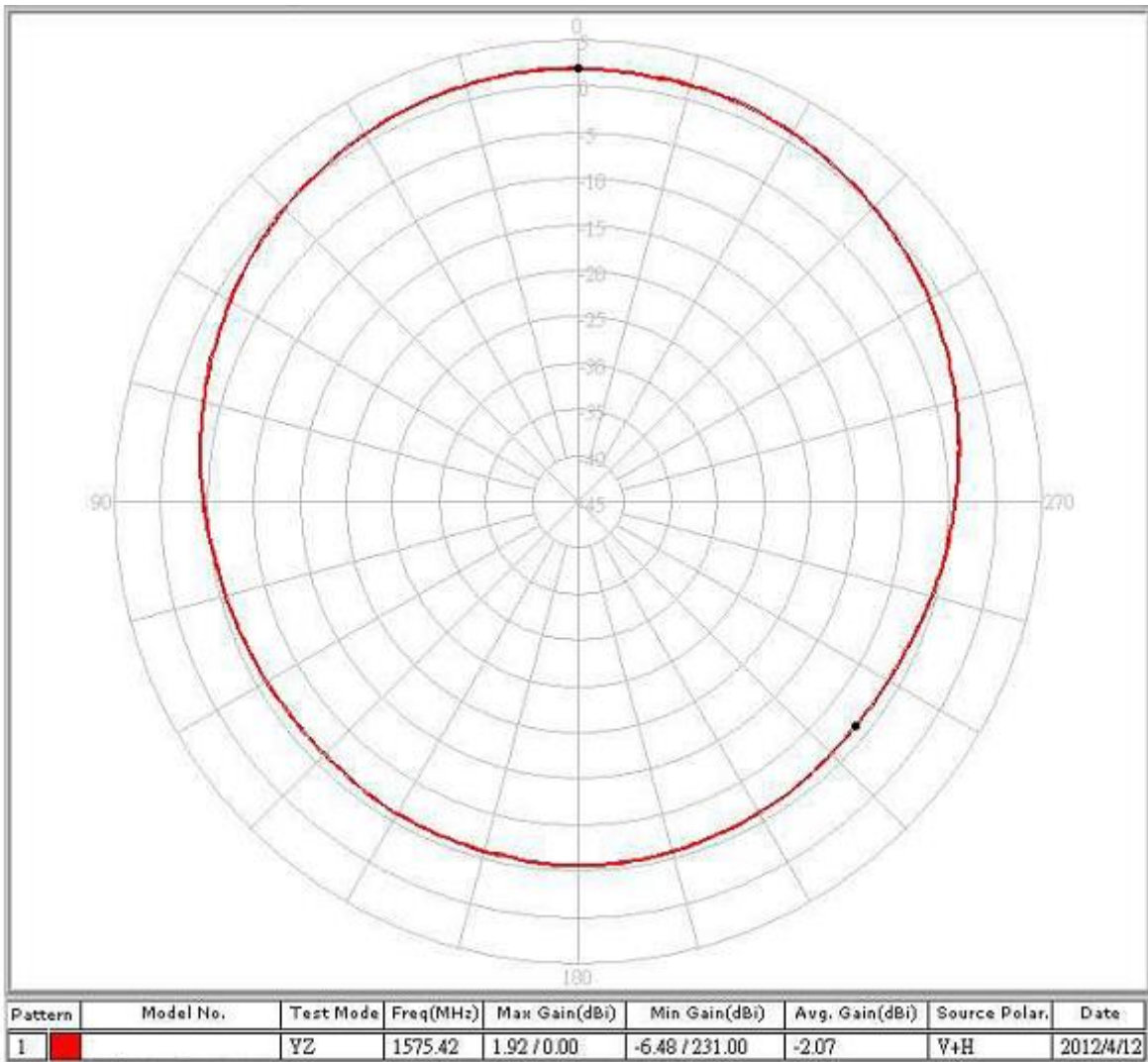

1575 MHz	Peak Gain	Zenith Gain
V+H	1.92	1.92

(dBi)

YZ Plane 1602MHz Horizontal & Vertical

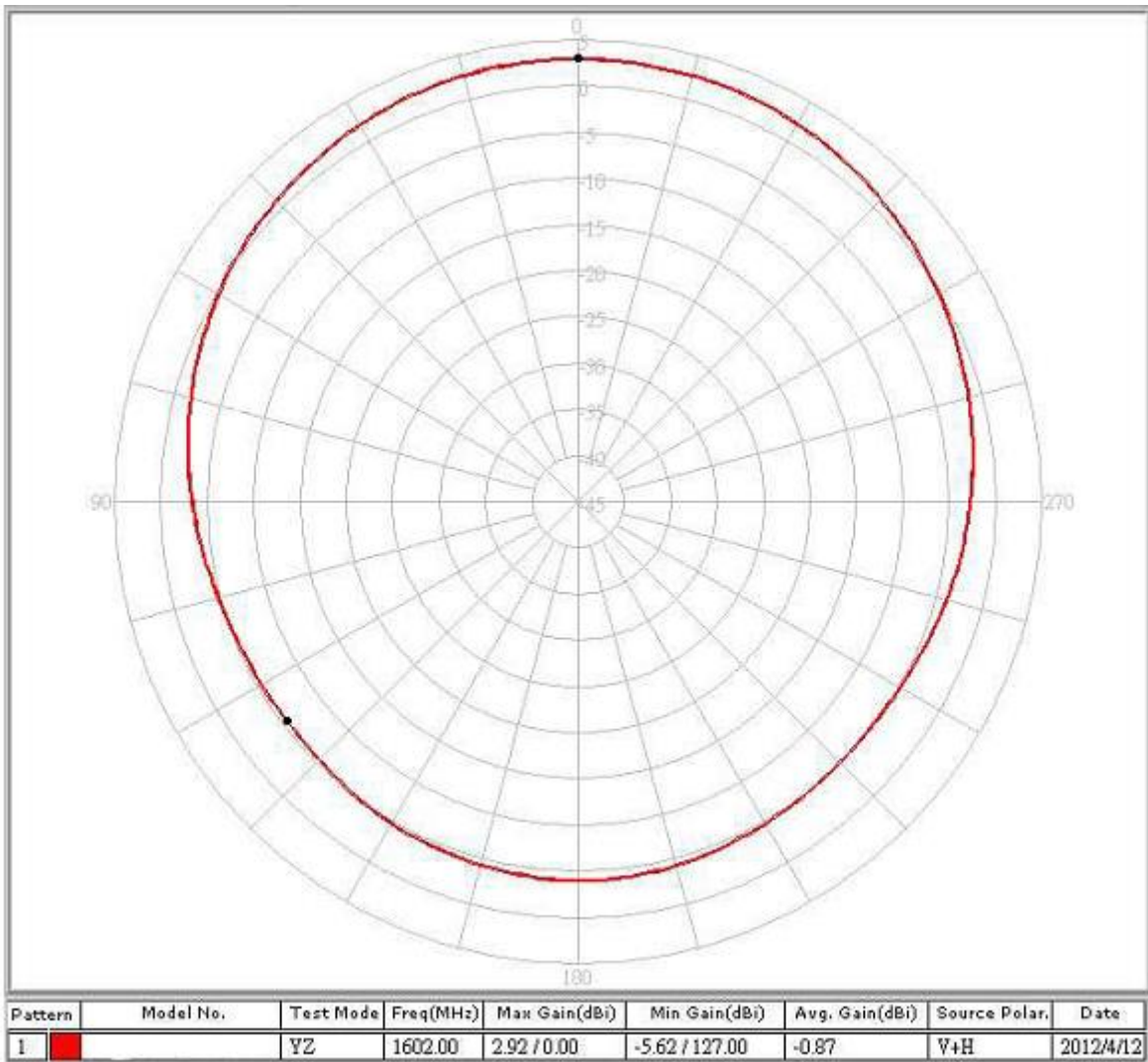

1602 MHz	Peak Gain	Zenith Gain
V+H	2.92	2.92

(dBi)

3.5. LNA characteristics

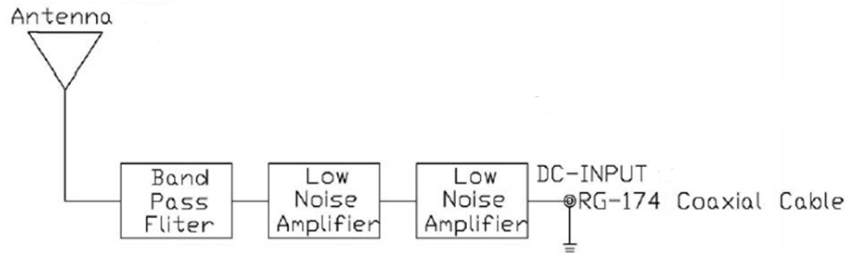

Output Impedance	50 Ohm
Output Power at 1dB Compression Point	-35dBm typ.
Output VSWR	2.0 Max.

Supply Voltage	Gain(Typ)	Noise Figure(Typ)	Power Consumption (Typ.)
1.8V	27.0dB	2.2dB	5.5mA
3.0V	32.9dB	2.3dB	12.5mA
5.5V	33.8dB	2.5dB	15.0mA

LNA Noise Figure at 3.0V

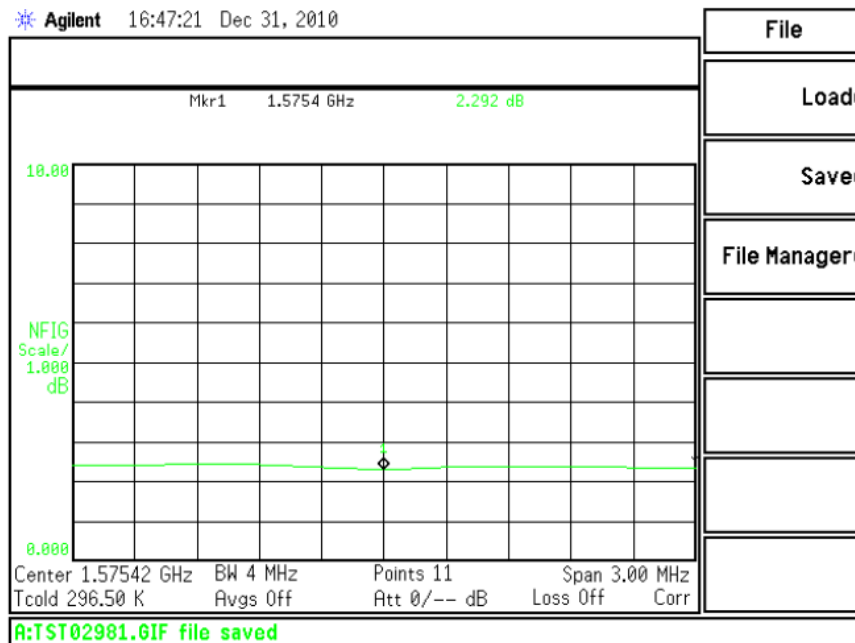

LNA Gain and Output of VSWR at 3.0V

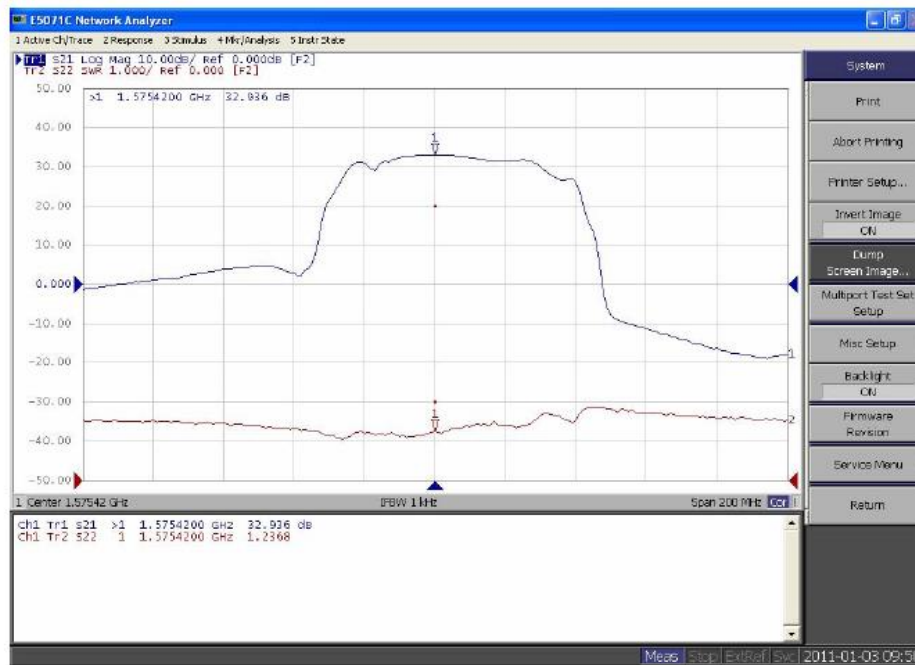

20dBmin isolation to LNA input and LTE/ GSM/ CDMA/UMTS /HSPA antenna

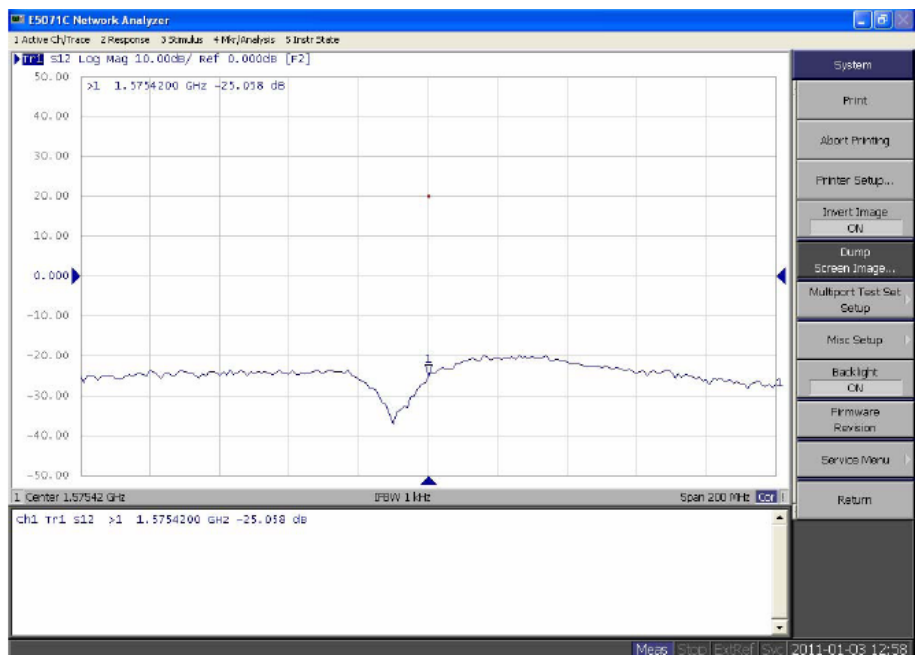

4. Cellular 2G/3G/4G antenna

4.1. Return Loss

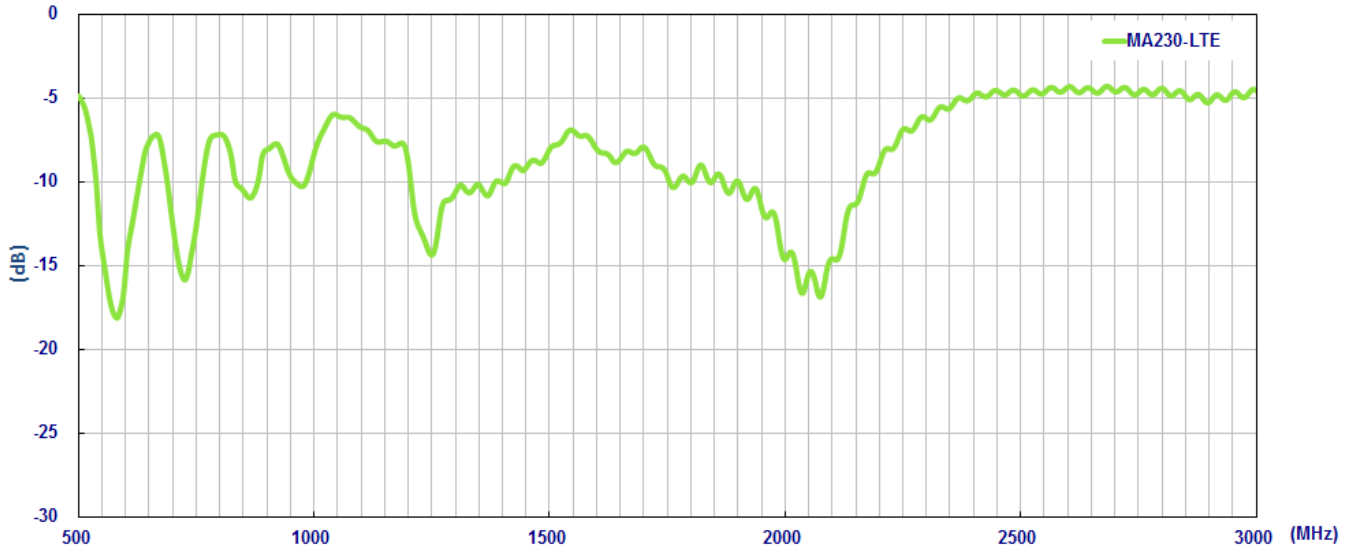

4.2. Efficiency

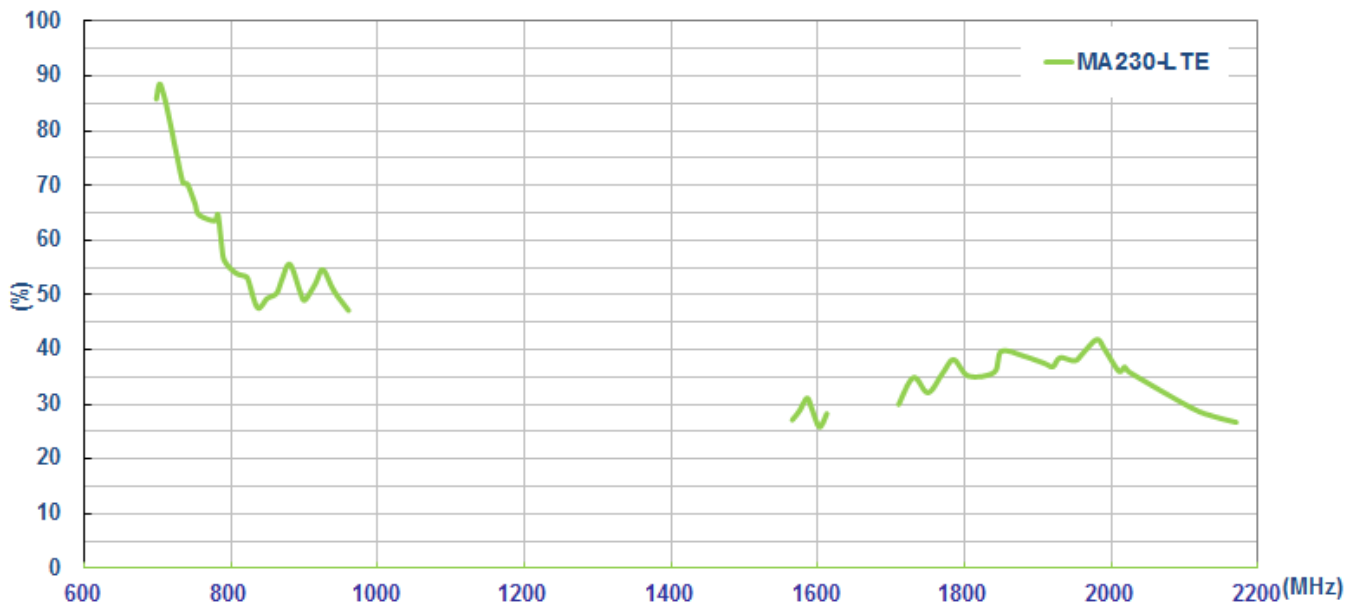

4.3. Peak Gain

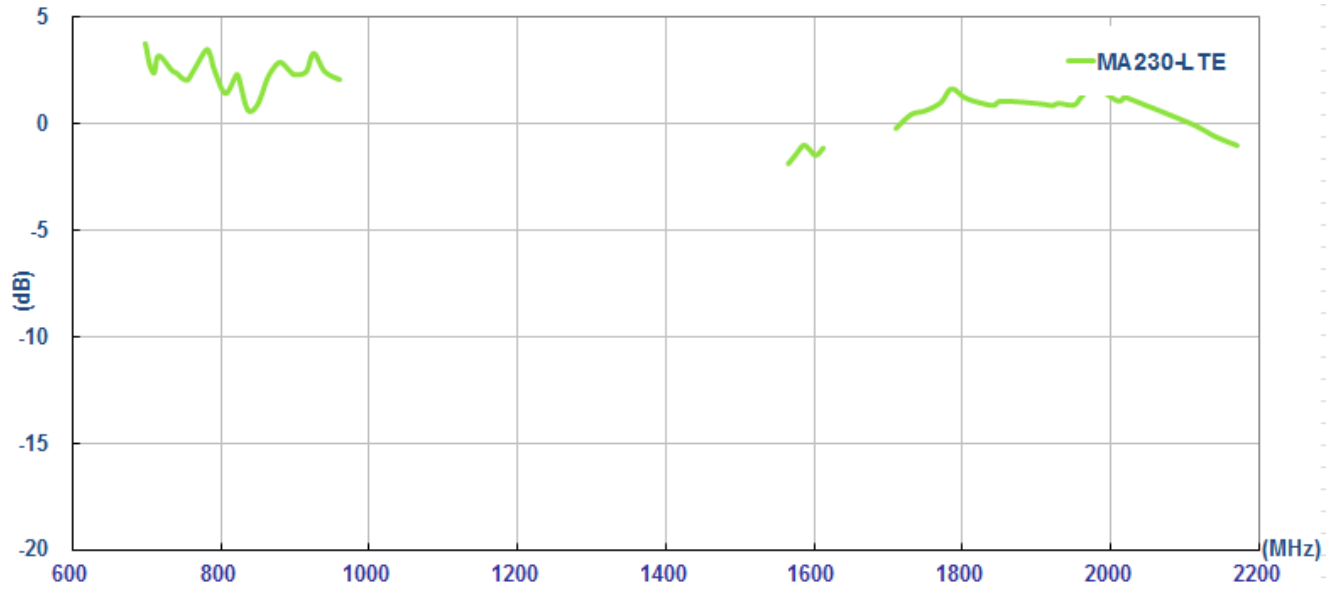

4.4. Average Gain

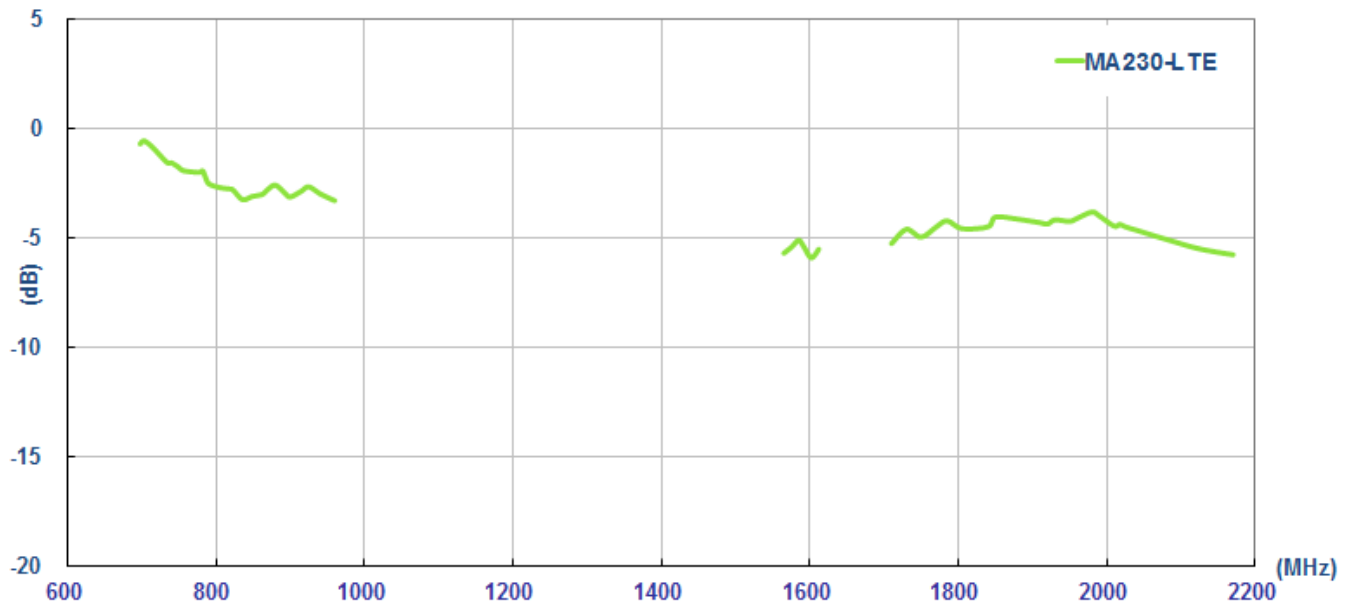

4.5. Radiation patterns

Measurement setup

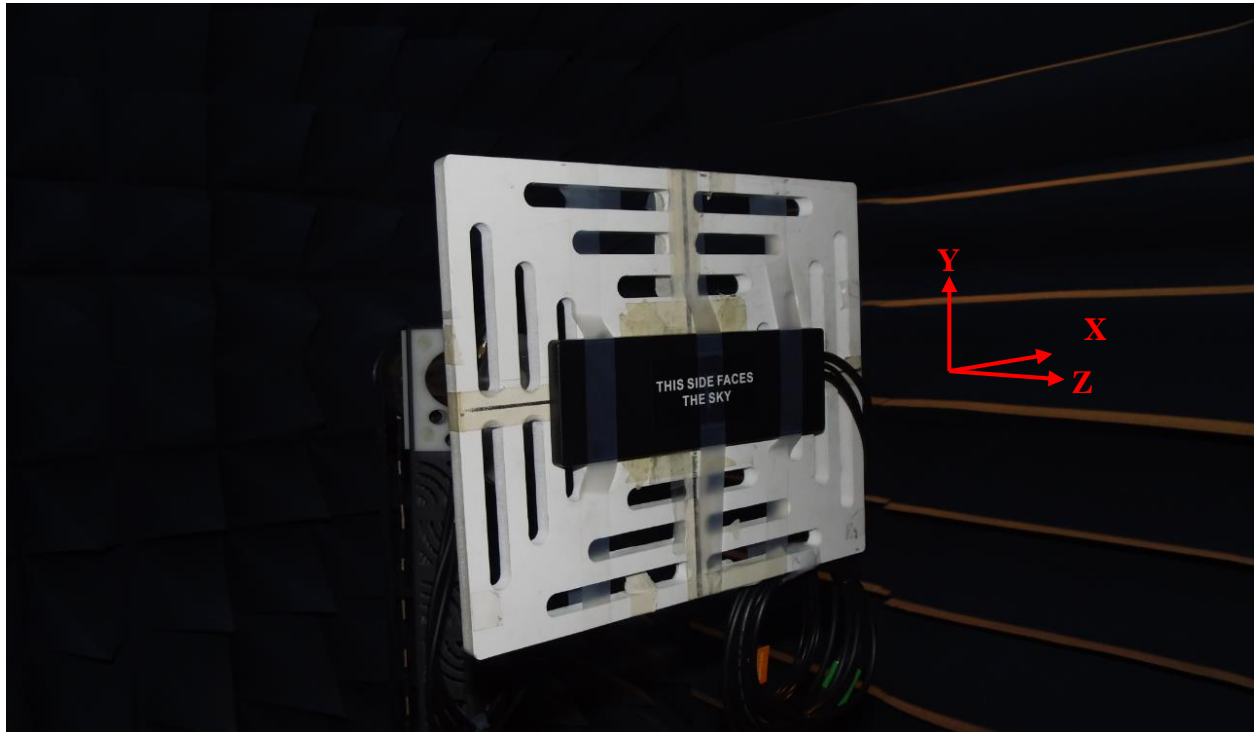

XY Plane

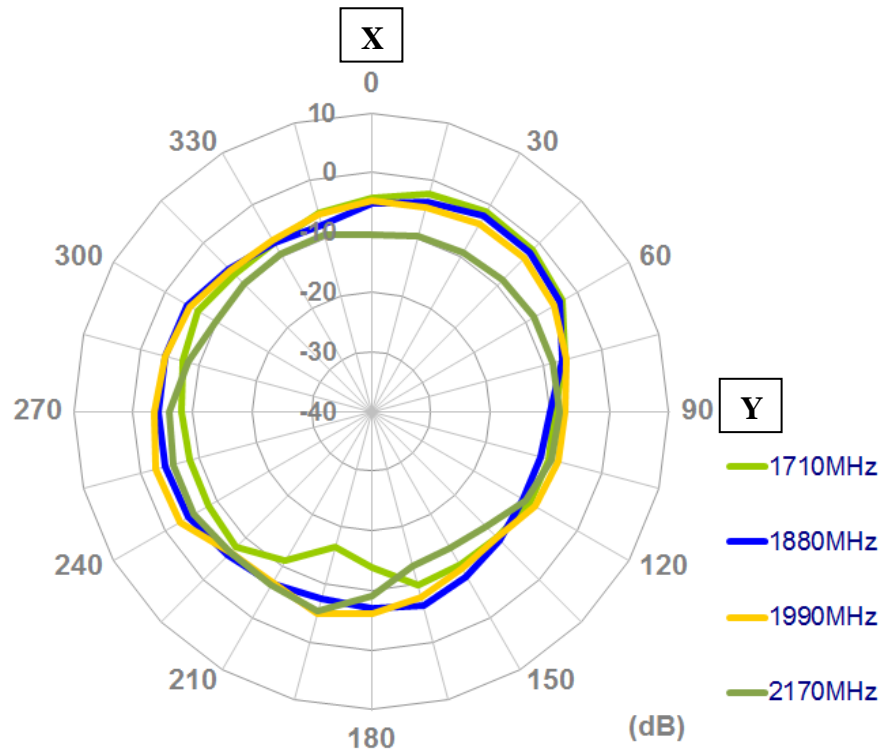
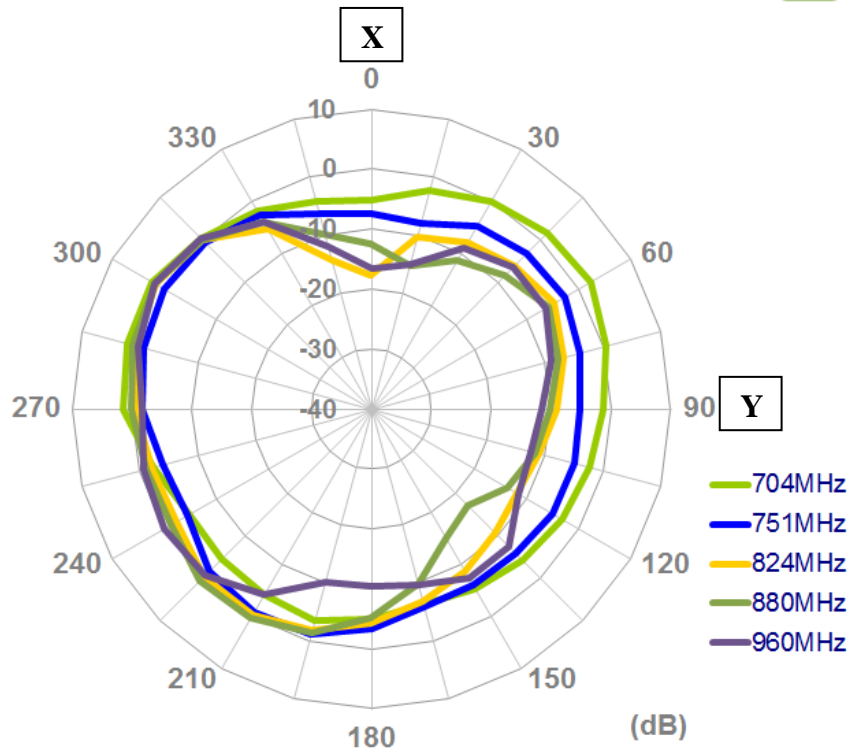

XZ Plane

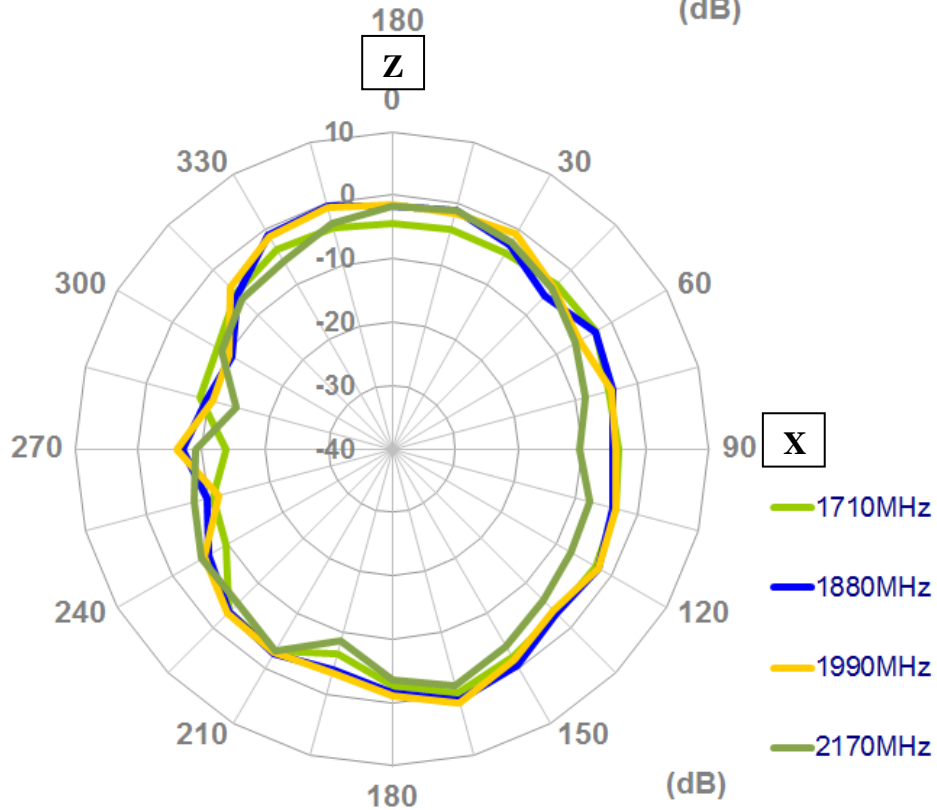
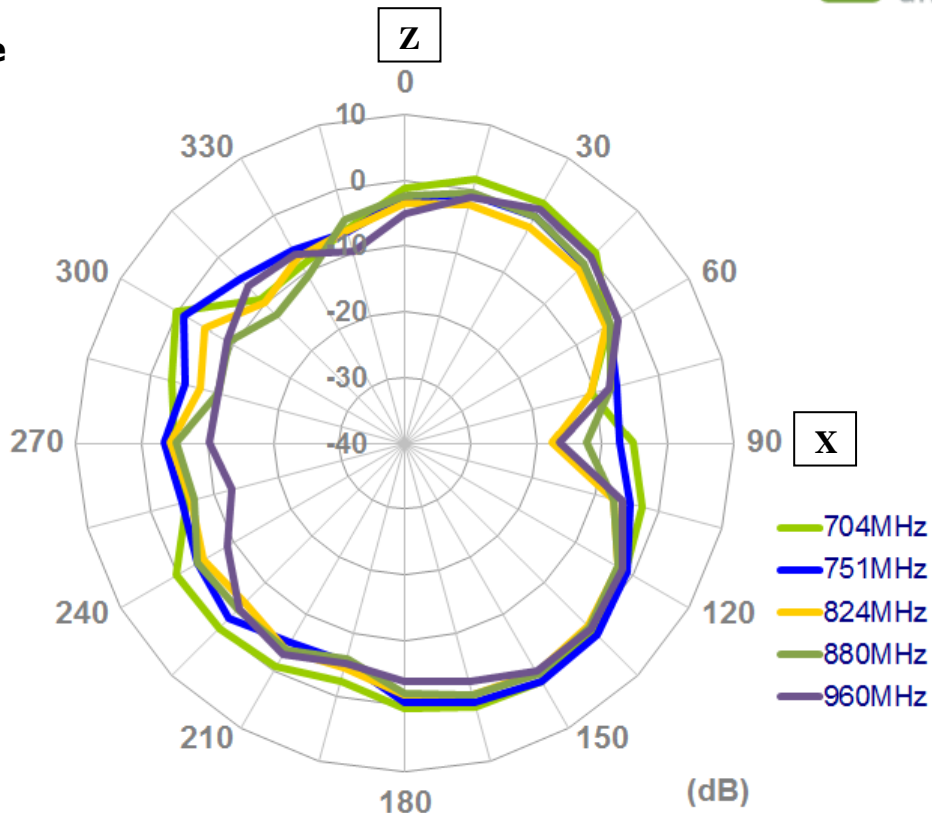

YZ Plane

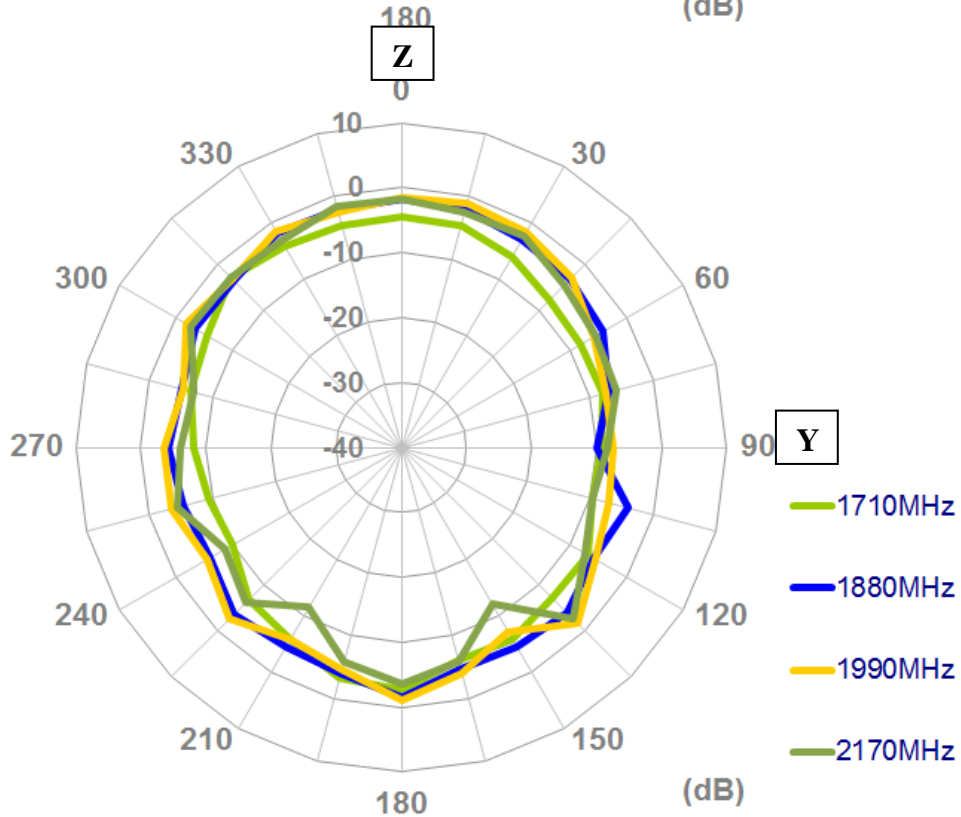
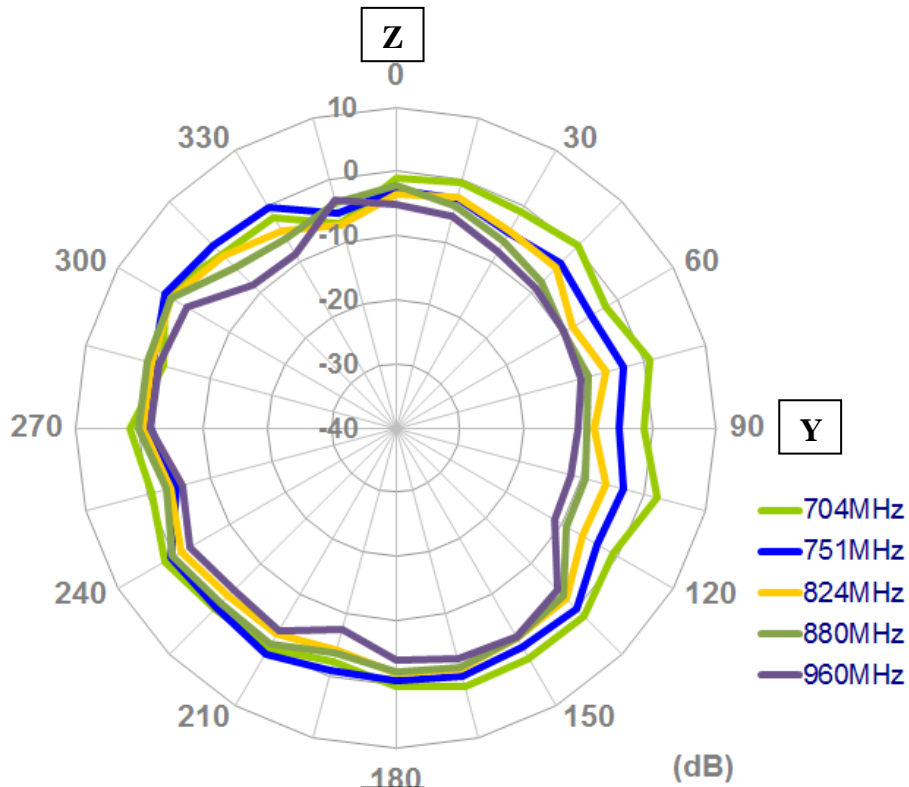

5. Wi-Fi 2.4/5.0 GHz antenna

5.1. Return Loss

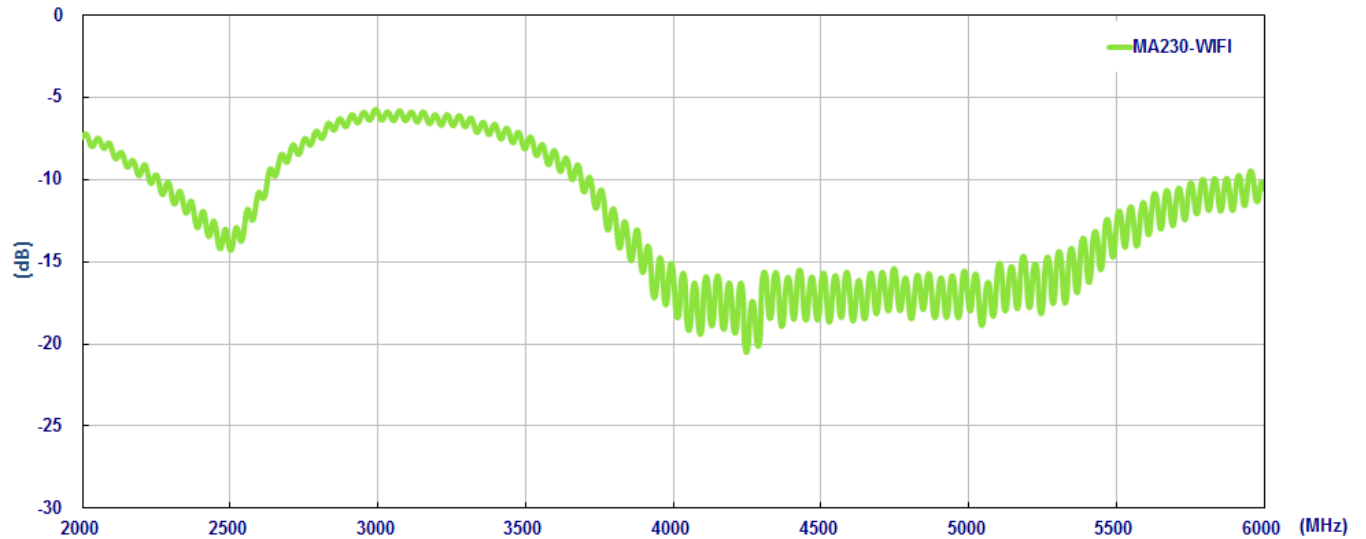

5.2. Efficiency

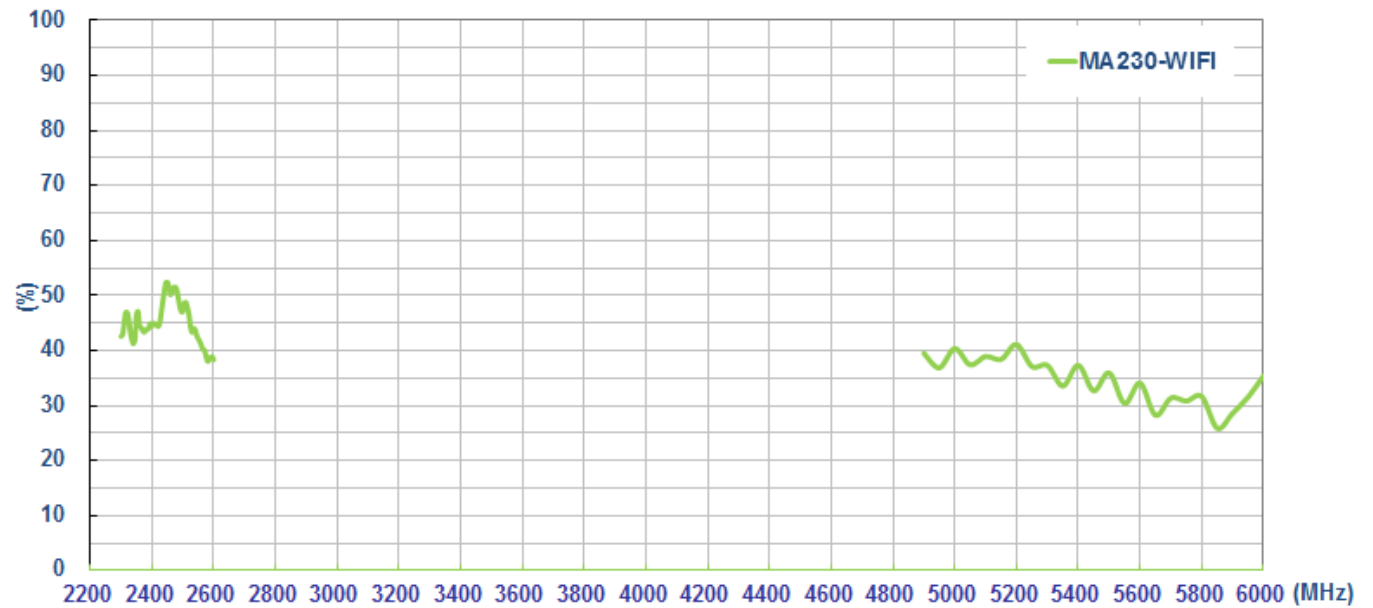

5.3. Peak Gain

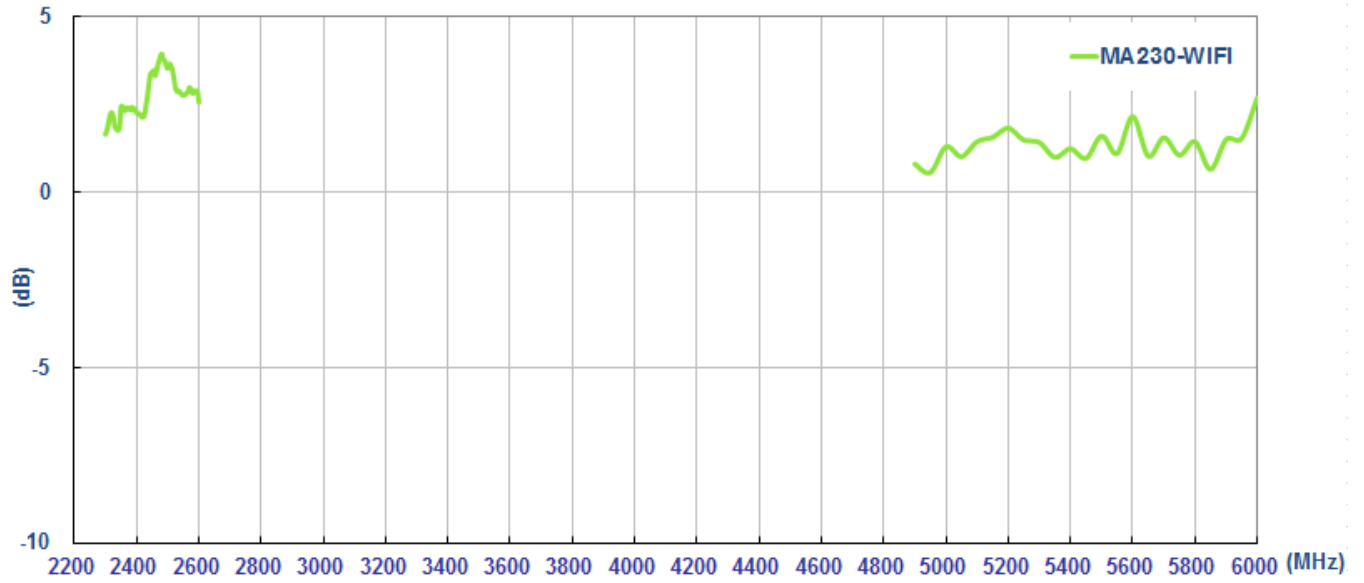

5.4. Average Gain

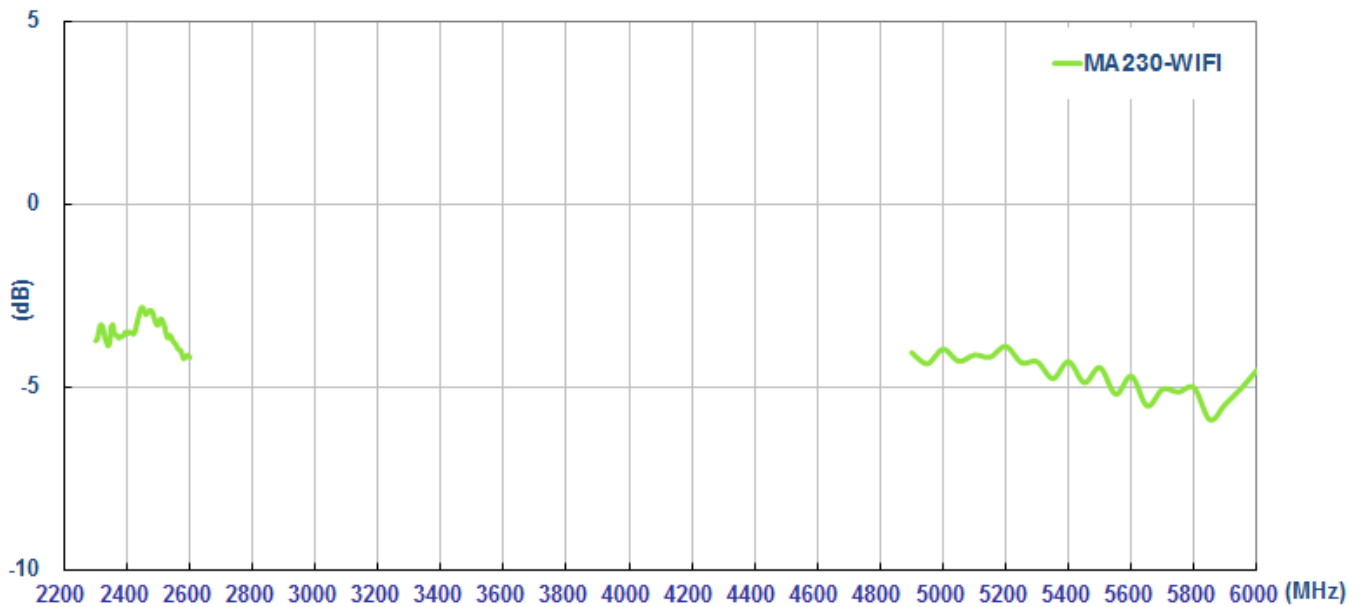

5.5. Radiation patterns

Measurement setup

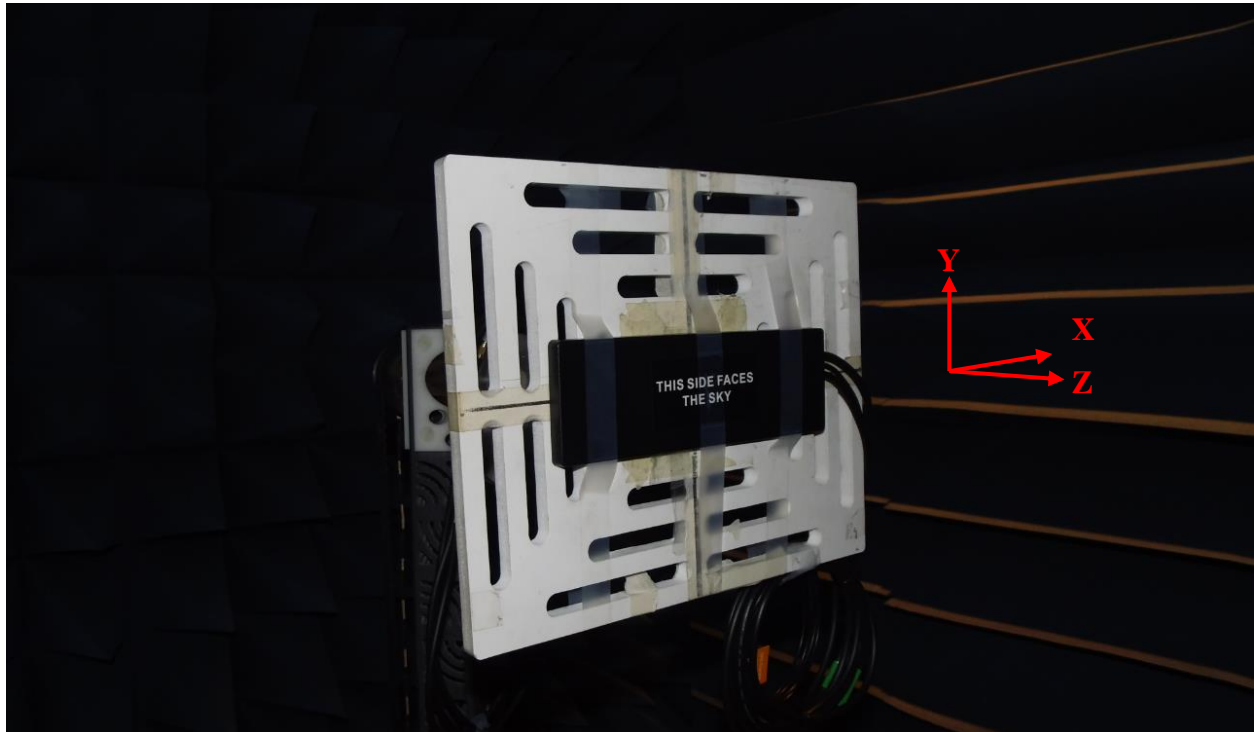

XY Plane

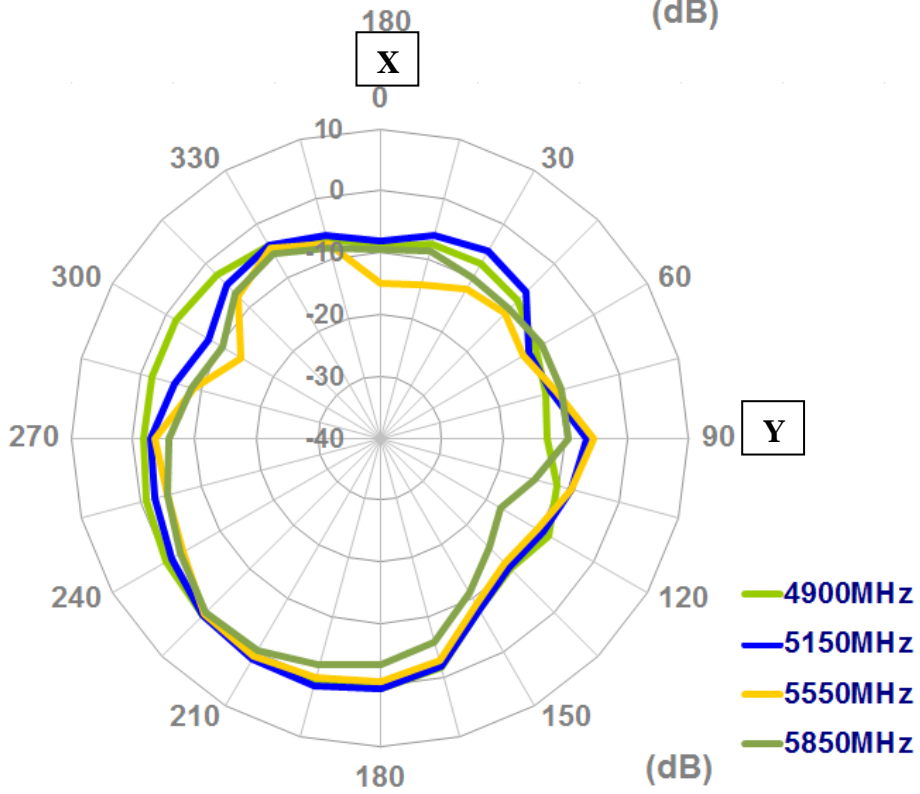
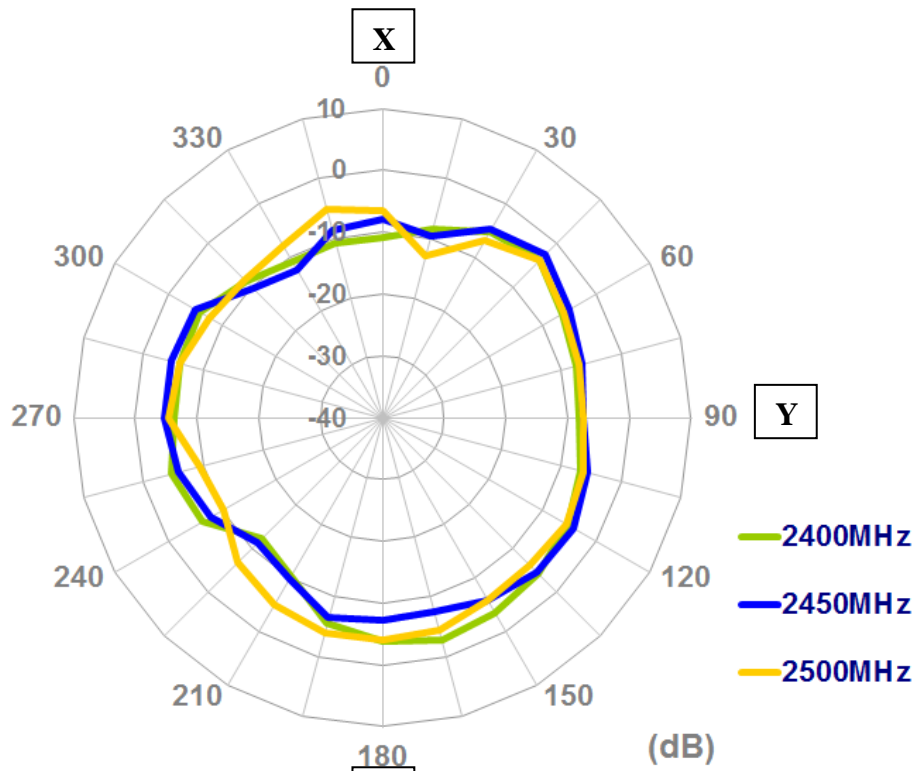

XZ Plane

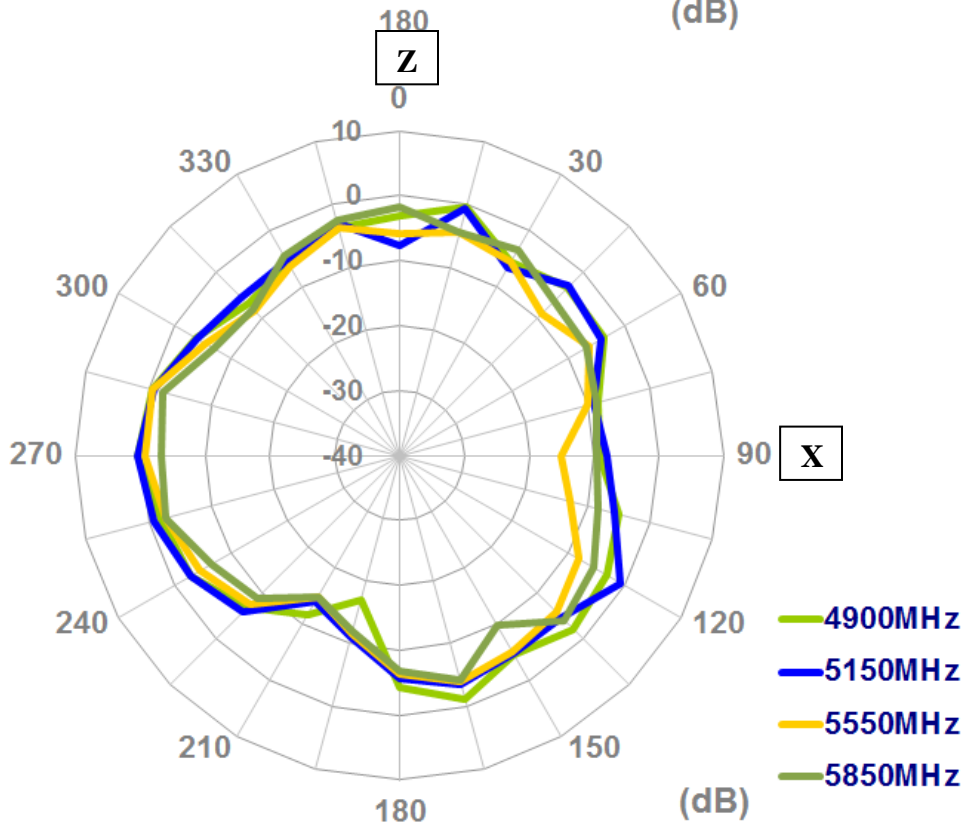
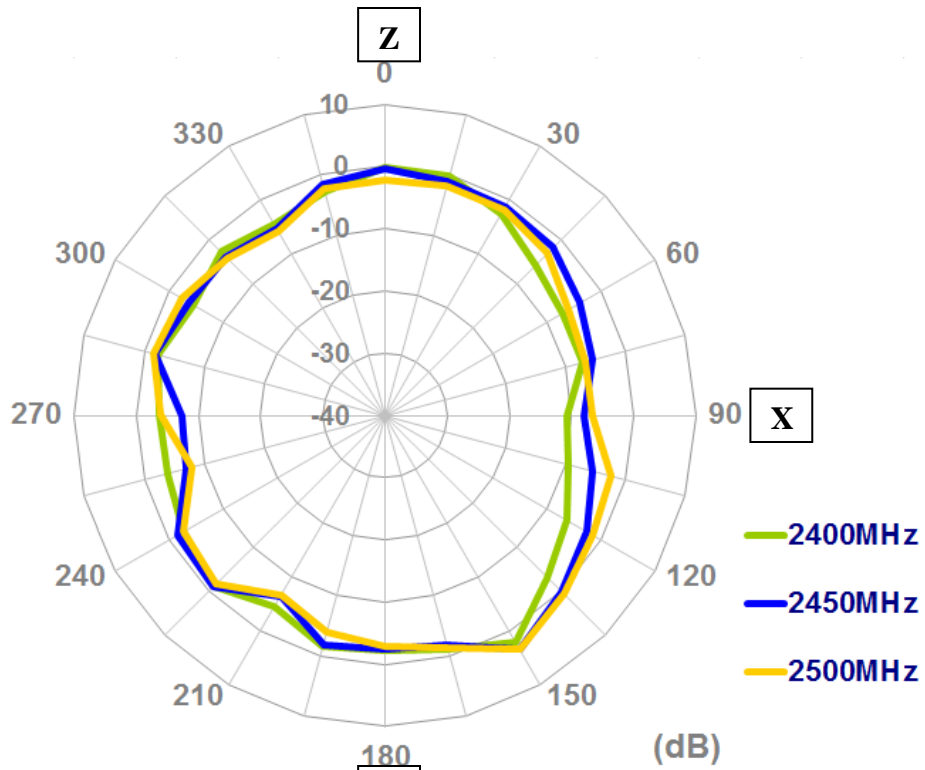

YZ Plane

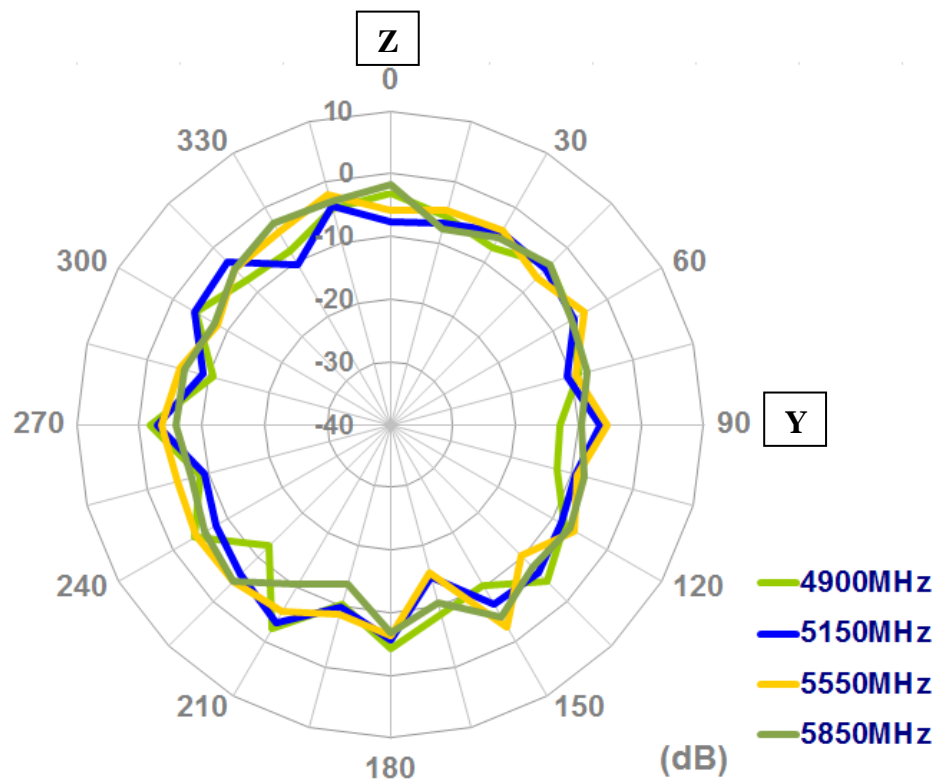
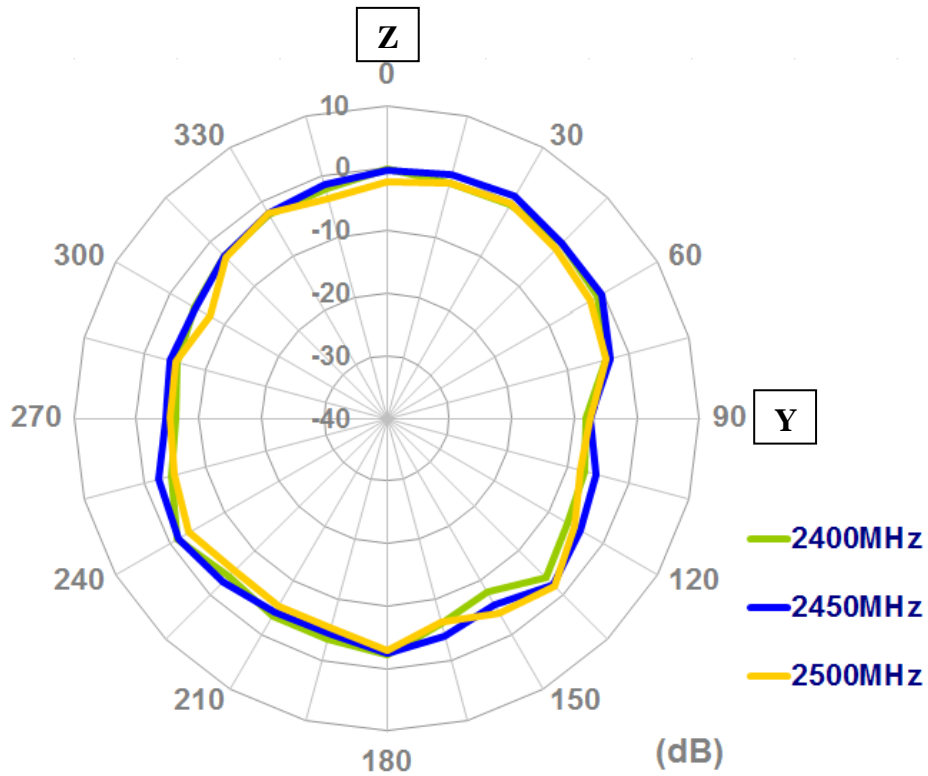

8. Drawing

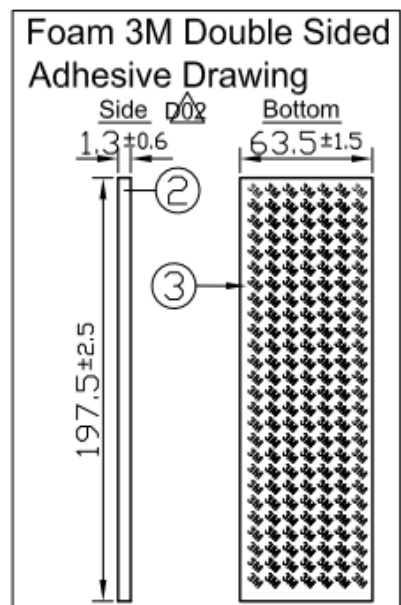
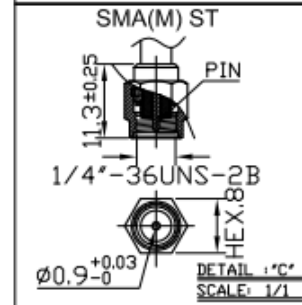
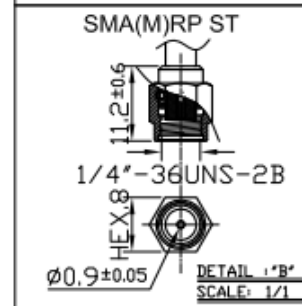
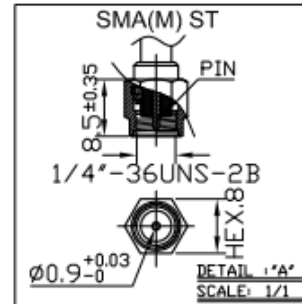
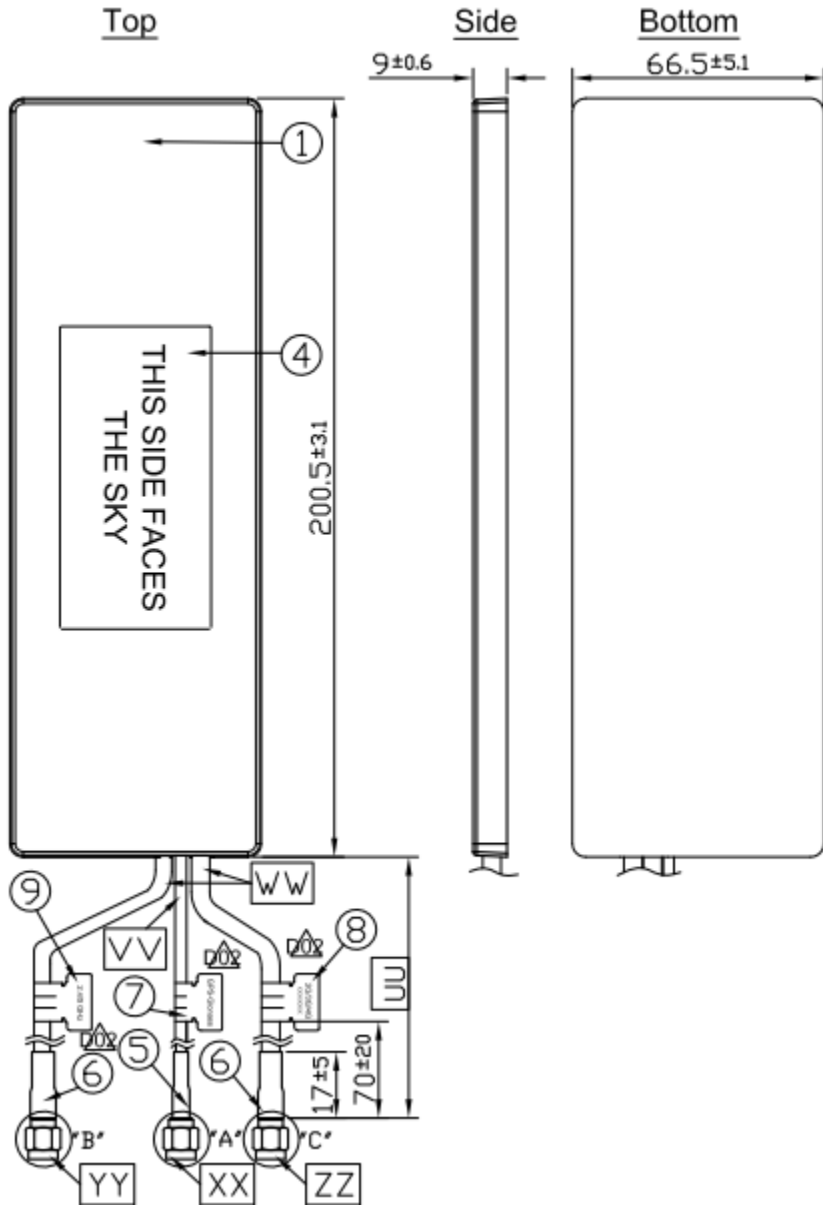

	Name	Material	Finish	QTY
1	Housing	ABS	Black	1
2	Closed Cell Foam	F100	Black	1
3	3M Double Adhesive	3M 9448 B	White Liner	1
4	Clear Label	PET	Transparent	1
5	Heat Shrink Tube (RG-174)	PE	Black	1
6	Heat Shrink Tube (CFD-200)	PE	Black	2
7	GPS-Glonass Label (48*30)	Coated Paper	Orange	1
8	2G/3G/4G Label (48*30)	Coated Paper	White	1
9	2.4GHz/5GHz Lable (48*30)	Coated Paper	Green	1
	Name	Spec	Finish	QTY
UU	Cable Length	3000±120 mm		3
VV	Cable Type	RG-174	Black	1
WW	Cable Type	CFD-200	Black	2
XX	Connector Type	SMA(M) ST	Gold	1
YY	Connector Type	SMA(M)RP ST	Gold	1
ZZ	Connector Type	SMA(M) ST	Gold	1

9. Packaging

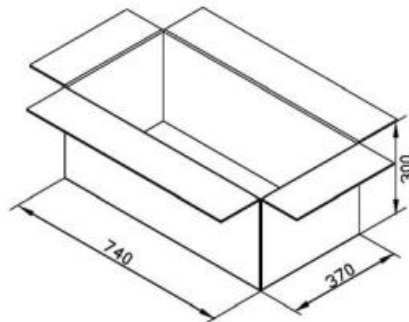
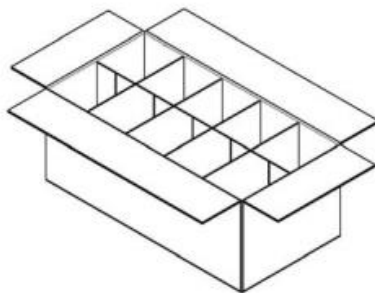
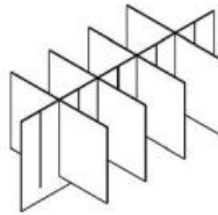
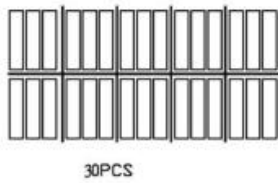
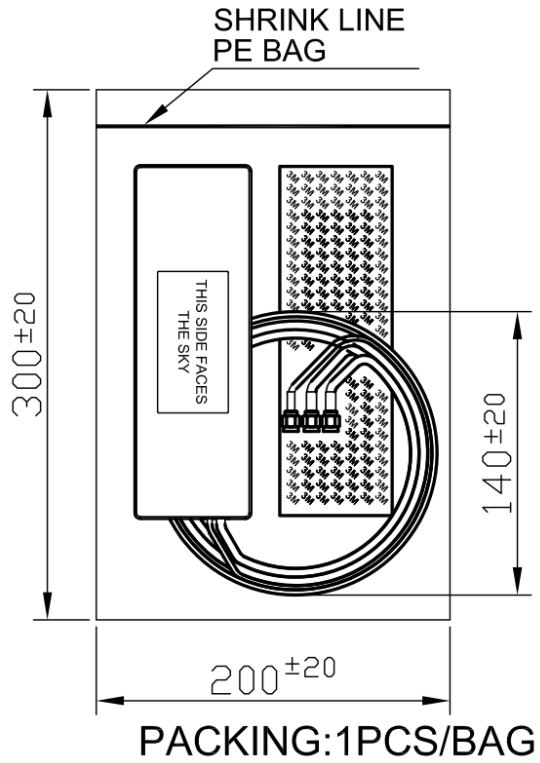



Taoglas makes no warranties based on the accuracy or completeness of the contents of this document and reserves the right to make changes to specifications and product descriptions at any time without notice. Taoglas reserves all rights to this document and the information contained herein.

Reproduction, use or disclosure to third parties without express permission is strictly prohibited.

Copyright © Taoglas Ltd.