

GlobTek, Inc. www.globtek.com 186 Veterans Drive, Northvale, NJ 07647 Tel. (201) 784-1000 Fax (201) 784-0111	Drawing Title: GT-86060-0605-W2, ITE Power Supply, Efficiency Level: VI, Case Color/Style: White C-62, Wall Plug-in, Regulated Switchmode AC-DC Power Supply AC Adaptor, Input Rating: 100-240V- , 50/60Hz, N. America NEMA 1-15 Fixed , Output Rating: 6W, 5V@1.2A, Output Configuration: 1500 mm, 22/2 Cond, UL 2468, Micro USB type B without resistor, Ferrite: None, White C-62, GT Cord # C3786, Pin Out: Pin 1: +V, Pin 2-4: N/C, Pin 5: GND, Blades/Input Cord: Fixed Blades North American 1-15P, Approvals: EAC cUL China RoHS PSE WEEE Ukraine RoHS PSE Level VI Double Insulation VCCI CE SGS LPS	
	Model No. GT-86060-0605-W2	
	Part No./Ordering No. WR9HA1200MICB-F(R6W)	Rev B

REVISION HISTORY

REV	DESCRIPTION	SUB	DATE	APPROVED
B	Change O/P cord from 24AWG to 22AWG	QA	10/27/2016	QA
A	Initial Release	svlas	07/07/2016	QA

In Addition to GlobTek Inc.'s renewed ISO9001:2008 - Quality Management System Certification, GlobTek Inc. is now certified to:

ISO13485:2003 - Medical Devices Quality Management System Certification
ISO14001:2004 - Environmental Management System Certification

ISO Certificates are available online at <http://www.globtek.com/iso-certificates/>

Customer Approval of Specification:

Please approve, sign and send back to GlobTek so we can complete order processing.

A delay in receipt of this form will delay delivery schedule.

Company Name:

Customer P/N:

Quote Number:

Date:

Authorized Representative Name:

Authorized Representative Signature:

The acceptance of this specification and use of the product described in this document indicates the acceptance and binding of the customer to Globtek terms and conditions, which supersede all other agreements, terms, and conditions (<http://en.globtek.com/terms-and-conditions/>).

Footnote:

GlobTek Inc. will not be liable for the safety and performance of these power supplies if unauthorized access and repair occurs. End user should consult applicable UL, CSA or EN standards for proper installation instruction.

Limitation of Use:

GlobTek product are not authorized for use as mission critical components in life support hazardous environment, nuclear or aircraft applications without prior written approval from the CEO of GlobTek Inc.

Contents of this document are subject to change without prior notice.

GT-86060-0605-W2, 6W, 5V@1.2A, Wall Plug-in, Regulated Switchmode AC-DC Power Supply AC Adaptor

PROPRIETARY INFORMATION

PROPRIETARY OF GLOBTEK, INC. ANY REPRODUCTION, DISCLOSURE OR USE OF THIS DRAWING, IN WHOLE OR IN PART, IS HEREBY PROHIBITED EXCEPT AS SPECIFIED IN WRITING BY GLOBTEK, INC.

Page 1 of 11

quest /08/20/2018 7:42:41 AM

GloTek, Inc. www.globtek.com 186 Veterans Drive, Northvale, NJ 07647 Tel. (201) 784-1000 Fax (201) 784-0111	Drawing Title: GT-86060-0605-W2, ITE Power Supply, Efficiency Level: VI, Case Color/Style: White C-62, Wall Plug-in, Regulated Switchmode AC-DC Power Supply AC Adaptor, Input Rating: 100-240V- , 50/60Hz, N. America NEMA 1-15 Fixed , Output Rating: 6W, 5V@1.2A, Output Configuration: 1500 mm, 22/2 Cond, UL 2468, Micro USB type B without resistor, Ferrite: None, White C-62, GT Cord # C3786, Pin Out: Pin 1: +V, Pin 2-4: N/C, Pin 5: GND, Blades/Input Cord: Fixed Blades North American 1-15P, Approvals: EAC cUL China RoHS PSE WEEE Ukraine RoHS PSE Level VI Double Insulation VCCI CE SGS LPS	
	Model No. GT-86060-0605-W2	
	Part No./Ordering No. WR9HA1200MICB-F(R6W)	Rev B

POWER SUPPLY INFORMATION

TYPE: Wall Plug-in
TECHNOLOGY: Regulated Switchmode AC-DC Power Supply AC Adaptor
CASE COLOR: White C-62
NAMEPLATE RATED INPUT: 100-240V- , 50/60Hz, 0.2A
INPUT CONFIG: N. America NEMA 1-15 Fixed
WATTS: 6.0
VOLTS OUT: 5
CURRENT OUT (Amps): 1.2
BLADE/CORD INCLUDED: FBNA2:
BLADE/CORD INSTALLED: FBNA2:
GROUNDING CONFIGURATION(F1) Class II / Double Insulated
EFFICIENCY LEVEL: VI
OUTPUT CONFIGURATION 1500 mm, 22/2 Cond, UL 2468, Micro USB type B without resistor, Ferrite: None, White C-62, GT Cord # C3786
CONNECTOR PIN OUT: Pin 1: +V, Pin 2-4: N/C, Pin 5: GND
LABEL SPECS: Standard GT WHITE,L-1288
PACK SPEC: Standard WPI, Individually Box

Notes/Modifications/Customizations (notes in this section supersede the values shown in the standard spec):

DIMENSIONS ARE IN MM UNLESS SPECIFIED OTHERWISE.

GlobTek, Inc. www.globtek.com 186 Veterans Drive, Northvale, NJ 07647 Tel. (201) 784-1000 Fax (201) 784-0111	Drawing Title: GT-86060-0605-W2, ITE Power Supply, Efficiency Level: VI, Case Color/Style: White C-62, Wall Plug-in, Regulated Switchmode AC-DC Power Supply AC Adaptor, Input Rating: 100-240V- , 50/60Hz, N. America NEMA 1-15 Fixed , Output Rating: 6W, 5V@1.2A, Output Configuration: 1500 mm, 22/2 Cond, UL 2468, Micro USB type B without resistor, Ferrite: None, White C-62, GT Cord # C3786, Pin Out: Pin 1: +V, Pin 2-4: N/C, Pin 5: GND, Blades/Input Cord: Fixed Blades North American 1-15P, Approvals: EAC cUL China RoHS PSE WEEE Ukraine RoHS PSE Level VI Double Insulation VCCI CE SGS LPS	
	Model No. GT-86060-0605-W2	
	Part No./Ordering No. WR9HA1200MICB-F(R6W)	Rev B

ELECTRICAL SPECIFICATIONS

A) ELECTRICAL SPECIFICATIONS:

01. Input Voltage: Specified 90-264 Vac, Nameplate rated: 100-240Vac
02. Input Frequency: Specified 47-63 Hz, Nameplate rated 50-60Hz
03. Output Regulation: +/- 5%
04. Ripple and Noise (Vp-p): 300 mVp-p maximum, At 20 MHz, and output parallel with 0.1uF & 47uF capacitors to ground. Temperature at 25 °C, and nominal input voltage
05. Efficiency: Compliant with Efficiency Level VI and CoC Tier 2 standards
07. No Load Standby Power: <0.075W @ 230Vac
08. Turn-ON Delay: 3 Seconds maximum at nominal input voltage
09. Rise Time: 100mS maximum at nominal input voltage

B) PROTECTION

01. Over-Voltage
02. Over current protection
03. Short Circuit: Short circuit protection is to be included in the construction of the adaptor. The adaptor is designed to withstand continuous current of a short circuit on the output. The adaptor will be short circuit tolerant for an indefinite period.

C) SAFETY

01. Dielectric Withstand Voltage: Primary To Secondary: 3000VAC 10mA 1minute or 4242VDC 10mA 1minute
02. Leakage current: 0.25mA maximum

D) OTHER:

01. MTBF: 200,000 Hours @ 25°C ambient temperature
02. Operating Temperature: 0°C to 40°C ambient temperature
03. Humidity: 0% to 90% relative humidity
04. Storage Temperature: -20°C to 60°C
05. Cooling: natural convection cooling
06. ROHS 2: Complies with EU 2011/65/EU and China SJ/T 11363-2006

E) ENCLOSURE

01. Housing: High impact plastic, 94V0 polycarbonate, non-vented
02. Markings: Label and/or Pad Printed and/or Molded in the case

GlobTek, Inc.
 www.globtek.com
 186 Veterans Drive,
 Northvale, NJ 07647
 Tel. (201) 784-1000
 Fax (201) 784-0111

Drawing Title: GT-86060-0605-W2, ITE Power Supply, Efficiency Level: VI, Case Color/Style: White C-62, Wall Plug-in, Regulated Switchmode AC-DC Power Supply AC Adaptor, Input Rating: 100-240V- , 50/60Hz, N. America NEMA 1-15 Fixed , Output Rating: 6W, 5V@1.2A, Output Configuration: 1500 mm, 22/2 Cond, UL 2468, Micro USB type B without resistor, Ferrite: None, White C-62, GT Cord # C3786, Pin Out: Pin 1: +V, Pin 2-4: N/C, Pin 5: GND, Blades/Input Cord: Fixed Blades North American 1-15P, Approvals: EAC cUL China RoHS PSE WEEE Ukraine RoHS PSE Level VI Double Insulation VCCI CE SGS LPS

Model No. GT-86060-0605-W2

Part No./Ordering No. WR9HA1200MICB-F(R6W)

Rev B

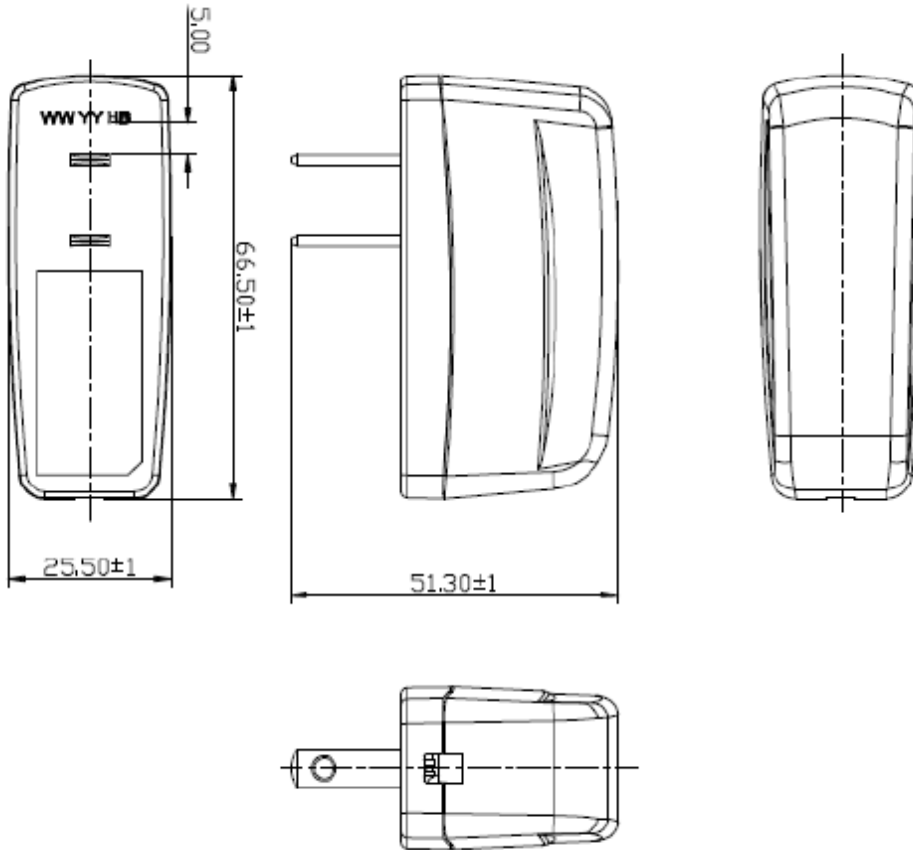

DERATING CURVE

GlobTek, Inc.
 www.globtek.com
 186 Veterans Drive,
 Northvale, NJ 07647
 Tel. (201) 784-1000
 Fax (201) 784-0111

Drawing Title: GT-86060-0605-W2, ITE Power Supply, Efficiency Level: VI, Case Color/Style: White C-62, Wall Plug-in, Regulated Switchmode AC-DC Power Supply AC Adaptor, Input Rating: 100-240V- , 50/60Hz, N. America NEMA 1-15 Fixed , Output Rating: 6W, 5V@1.2A, Output Configuration: 1500 mm, 22/2 Cond, UL 2468, Micro USB type B without resistor, Ferrite: None, White C-62, GT Cord # C3786, Pin Out: Pin 1: +V, Pin 2-4: N/C, Pin 5: GND, Blades/Input Cord: Fixed Blades North American 1-15P, Approvals: EAC cUL China RoHS PSE WEEE Ukraine RoHS PSE Level VI Double Insulation VCCI CE SGS LPS

Model No. GT-86060-0605-W2

Part No./Ordering No. WR9HA1200MICB-F(R6W)

Rev B

Typical External Power Supply Derating Curve

(For Efficiency Level V and Efficiency Level VI Products)

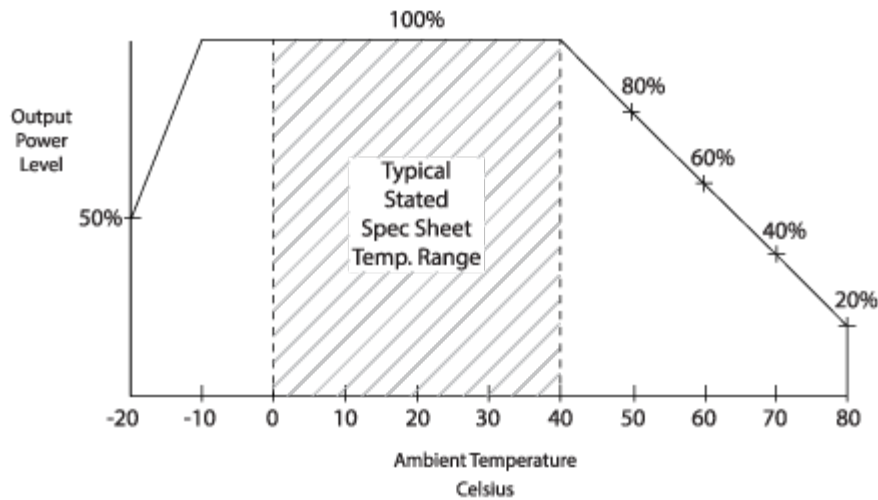

GlobTek, Inc. www.globtek.com 186 Veterans Drive, Northvale, NJ 07647 Tel. (201) 784-1000 Fax (201) 784-0111	Drawing Title: GT-86060-0605-W2, ITE Power Supply, Efficiency Level: VI, Case Color/Style: White C-62, Wall Plug-in, Regulated Switchmode AC-DC Power Supply AC Adaptor, Input Rating: 100-240V- , 50/60Hz, N. America NEMA 1-15 Fixed , Output Rating: 6W, 5V@1.2A, Output Configuration: 1500 mm, 22/2 Cond, UL 2468, Micro USB type B without resistor, Ferrite: None, White C-62, GT Cord # C3786, Pin Out: Pin 1: +V, Pin 2-4: N/C, Pin 5: GND, Blades/Input Cord: Fixed Blades North American 1-15P, Approvals: EAC cUL China RoHS PSE WEEE Ukraine RoHS PSE Level VI Double Insulation VCCI CE SGS LPS	
	Model No. GT-86060-0605-W2	
	Part No./Ordering No. WR9HA1200MICB-F(R6W)	Rev B

INPUT CONFIGURATION

Grounding Configuration:

Blades/Cord Included: FBNA2:

Blades/Cord Installed: FBNA2:

NEMA 1-15P, North America Blades, Class II 2 Conductors

All NEMA 1 devices are two-wire non-grounding devices (hot-neutral) rated for 125 V maximum. NEMA 1-15P plugs have two parallel flat blades, 0.25 inches (6.35 mm) wide, 0.06 inches (1.524 mm) thick, 0.625-0.718 inches (15.875–18.256 mm) long, and spaced 0.5 inches (12.7 mm) apart.

GloTek, Inc. www.globtek.com 186 Veterans Drive, Northvale, NJ 07647 Tel. (201) 784-1000 Fax (201) 784-0111	Drawing Title: GT-86060-0605-W2, ITE Power Supply, Efficiency Level: VI, Case Color/Style: White C-62, Wall Plug-in, Regulated Switchmode AC-DC Power Supply AC Adaptor, Input Rating: 100-240V- , 50/60Hz, N. America NEMA 1-15 Fixed , Output Rating: 6W, 5V@1.2A, Output Configuration: 1500 mm, 22/2 Cond, UL 2468, Micro USB type B without resistor, Ferrite: None, White C-62, GT Cord # C3786, Pin Out: Pin 1: +V, Pin 2-4: N/C, Pin 5: GND, Blades/Input Cord: Fixed Blades North American 1-15P, Approvals: EAC cUL China RoHS PSE WEEE Ukraine RoHS PSE Level VI Double Insulation VCCI CE SGS LPS	
	Model No. GT-86060-0605-W2	
	Part No./Ordering No. WR9HA1200MICB-F(R6W)	Rev B

OUTPUT CORD AND CONNECTOR: MICUSB/C3786

ACTUAL CONNECTORS, OVERMOLDS, FERRITES MAY VARY SLIGHTLY FROM THE PICTURE BELOW

CABLE TYPE	UL 2468
CABLE LENGTH (mm)	1500
CABLE TOLERANCE (mm)	+150 -0
WIRE GAUGE (AWG)	22
CONDUCTORS	2
HANK DIMENSION (mm)	80mm +/-10
CABLE / CONNECTOR OVERMOLD COLOR	White C-62
FERRITE TYPE / DIMENSION	None
FERRITE # OF TURNS (Definition)	N/A
FERRITE DIMENSION FROM STRAIN RELIEF	N/A
FERRITE DIMENSION FROM PLUG	N/A
PLUG TYPE	Micro USB type B without resistor
OVER MOLD ORIENTATION	Straight
CONNECTOR PIN OUT:	Pin 1: +V, Pin 2-4: N/C, Pin 5: GND
ADDITIONAL REQUIREMENTS	

PINOUT:

- PIN 1: +5V
- PIN 2: N/C
- PIN 3: N/C
- PIN 4: N/C
- PIN 5: GND

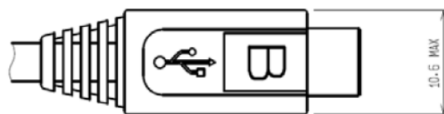
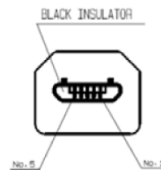
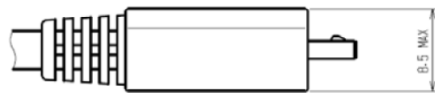

ADDITIONAL OUTPUT PLUG OPTIONS

ARE AVAILABLE AT <http://www.globtek.com/connectors/>
STANDARD PLUGS AND CONNECTORS CAN BE SEEN ONLINE AT <http://www.globtek.com/connectors/>

GlobTek, Inc. www.globtek.com 186 Veterans Drive, Northvale, NJ 07647 Tel. (201) 784-1000 Fax (201) 784-0111	Drawing Title: GT-86060-0605-W2, ITE Power Supply, Efficiency Level: VI, Case Color/Style: White C-62, Wall Plug-in, Regulated Switchmode AC-DC Power Supply AC Adaptor, Input Rating: 100-240V- , 50/60Hz, N. America NEMA 1-15 Fixed , Output Rating: 6W, 5V@1.2A, Output Configuration: 1500 mm, 22/2 Cond, UL 2468, Micro USB type B without resistor, Ferrite: None, White C-62, GT Cord # C3786, Pin Out: Pin 1: +V, Pin 2-4: N/C, Pin 5: GND, Blades/Input Cord: Fixed Blades North American 1-15P, Approvals: EAC cUL China RoHS PSE WEEE Ukraine RoHS PSE Level VI Double Insulation VCCI CE SGS LPS	
	Model No. GT-86060-0605-W2	
	Part No./Ordering No. WR9HA1200MICB-F(R6W)	Rev B

LABEL:L-1288

LABEL P/N: Standard GT WHITE
MATERIAL: Flat Thermal Transfer, Imprintable, Polyester Label and/or Pad Printed and/or Molded in the case
BACKGROUND COLOR: Black if housing is Black, White or Silver if housing is White or Gray.
TEXT COLOR: White or Silver if label is Black Background for Black housing. Black if label is White or Silver background and Housing is White or Gray
LABEL WIDTH (mm): 39.7
LABEL HEIGHT (mm): 16.2

Below is the minimum information which will appear on the label. NOTE: in the logo area additional/actual positioning of symbols and text is subjected to change as per agency updates/requirements or additional model approvals become available. Agency logos may be in Logo area on the label or molded into the case housing outside the label area. Information will be shown via Label and/or Pad Printed and/or Molded in the case

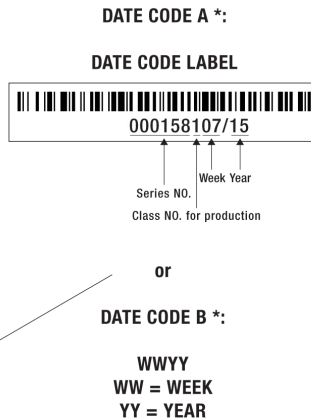

A=ITE Power Supply
 B=P/N: (料号) WR9HA1200MICB-F(R6W)
 C=Model (型号) GT-86060-0605-W2
 D=Input (输入) 100-240V- , 50/60Hz, 0.2A
 E=Output (输出) 5 V 1.2 A , 6.0W

- | | |
|---|---|
| AGENCY ONLINE DOCUMENTS | http://www.globtek.info/certs/GT-86060-WWVV-W2Z/ |
| CE EC-Declaration for Medical | Contact GlobTek for more information |
| CE EC-Declaration for Industrial/Commercial/ITE | http://www.globtek.com/pdf/ec_declaration/a00a000000MmdD4EAJ |
| RoHS/RoHS2 Declaration | http://www.globtek.com/pdf/rohs_cert/01ta0000006xHXzAAM |
| REACH Declaration | http://www.globtek.com/pdf/iso_certificates/REACH.pdf |
| Conflict Minerals Declaration | http://www.globtek.com/pdf/conflict-minerals.pdf |

GloTek, Inc. www.globtek.com 186 Veterans Drive, Northvale, NJ 07647 Tel. (201) 784-1000 Fax (201) 784-0111	Drawing Title: GT-86060-0605-W2, ITE Power Supply, Efficiency Level: VI, Case Color/Style: White C-62, Wall Plug-in, Regulated Switchmode AC-DC Power Supply AC Adaptor, Input Rating: 100-240V- , 50/60Hz, N. America NEMA 1-15 Fixed , Output Rating: 6W, 5V@1.2A, Output Configuration: 1500 mm, 22/2 Cond, UL 2468, Micro USB type B without resistor, Ferrite: None, White C-62, GT Cord # C3786, Pin Out: Pin 1: +V, Pin 2-4: N/C, Pin 5: GND, Blades/Input Cord: Fixed Blades North American 1-15P, Approvals: EAC cUL China RoHS PSE WEEE Ukraine RoHS PSE Level VI Double Insulation VCCI CE SGS LPS	
	Model No. GT-86060-0605-W2	
	Part No./Ordering No. WR9HA1200MICB-F(R6W)	Rev B

IPXY rating is based on 3rd party testing and customers should check suitability and test system level IPXY rating before ordering.

Regulatory Certifications/Label Markings

LATEST PRODUCT/MODEL CERTIFICATIONS: <http://en.globtek.com/datasheet/id/a00a000000MmdD4>

AGENCY ONLINE DOCUMENTS: <http://www.globtek.info/certs/GT-86060-WVVV-W2Z/>



Pin 1: +V, Pin 2-4: N/C, Pin 5: GND

GlobTek, Inc.
www.globtek.com
186 Veterans Drive,
Northvale, NJ 07647
Tel. (201) 784-1000
Fax (201) 784-0111

Drawing Title: GT-86060-0605-W2, ITE Power Supply, Efficiency Level: VI, Case Color/Style: White C-62, Wall Plug-in, Regulated Switchmode AC-DC Power Supply AC Adaptor, Input Rating: 100-240V- , 50/60Hz, N. America NEMA 1-15 Fixed , Output Rating: 6W, 5V@1.2A, Output Configuration: 1500 mm, 22/2 Cond, UL 2468, Micro USB type B without resistor, Ferrite: None, White C-62, GT Cord # C3786, Pin Out: Pin 1: +V, Pin 2-4: N/C, Pin 5: GND, Blades/Input Cord: Fixed Blades North American 1-15P, Approvals: EAC cUL China RoHS PSE WEEE Ukraine RoHS PSE Level VI Double Insulation VCCI CE SGS LPS

Model No. GT-86060-0605-W2

Part No./Ordering No. WR9HA1200MICB-F(R6W)

Rev B

PACKAGING

Packing Spec P/N: Standard WPI, Individually
Box

Box Qty: 120

Gift Box Size (mm): 90*48*62

Gift Box Color: White

Master Carton Size (mm): 470*310*284

Master GW (Kg): 15.6 kg

BLADES INCLUDED: FBNA2:

BLADE/CORD INSTALLED: FBNA2:

If specific packaging is required, this section must specify all requirements and note "no exceptions". If this section does not specify packaging, it is subject to change without notice at GlobTek's discretion

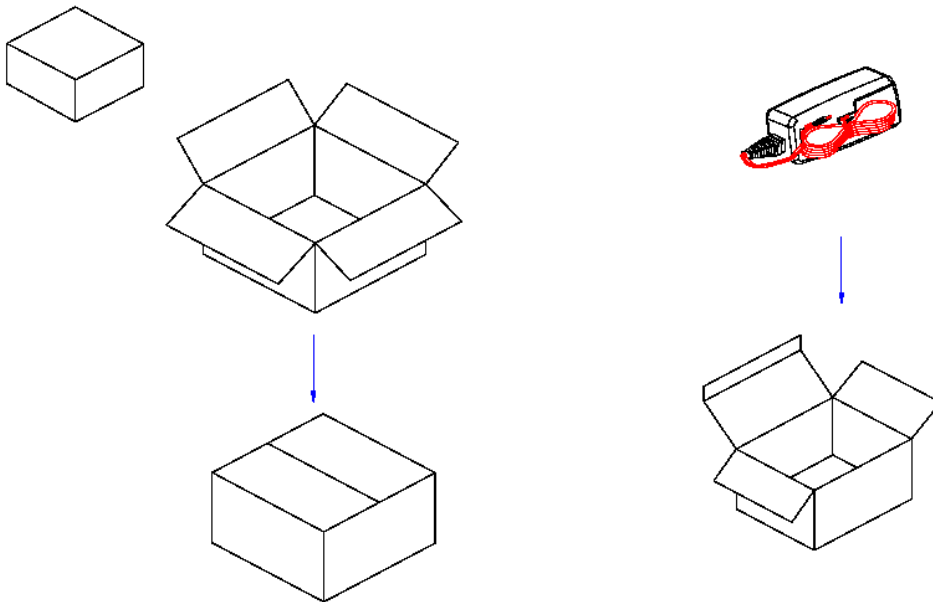

GlobTek, Inc. www.globtek.com 186 Veterans Drive, Northvale, NJ 07647 Tel. (201) 784-1000 Fax (201) 784-0111	Drawing Title: GT-86060-0605-W2, ITE Power Supply, Efficiency Level: VI, Case Color/Style: White C-62, Wall Plug-in, Regulated Switchmode AC-DC Power Supply AC Adaptor, Input Rating: 100-240V- , 50/60Hz, N. America NEMA 1-15 Fixed , Output Rating: 6W, 5V@1.2A, Output Configuration: 1500 mm, 22/2 Cond, UL 2468, Micro USB type B without resistor, Ferrite: None, White C-62, GT Cord # C3786, Pin Out: Pin 1: +V, Pin 2-4: N/C, Pin 5: GND, Blades/Input Cord: Fixed Blades North American 1-15P, Approvals: EAC cUL China RoHS PSE WEEE Ukraine RoHS PSE Level VI Double Insulation VCCI CE SGS LPS	
	Model No. GT-86060-0605-W2	
	Part No./Ordering No. WR9HA1200MICB-F(R6W)	Rev B

INSTRUCTION SHEET

N/A