





Grayhill, Inc.

62S11-N9-120S

Part Number:	62S11-N9-120S
Výrobce / značka:	Grayhill, Inc.
Popis produktu	ROTARY ENCODER OPTICAL 32PPR
Datasheety:	 62S11-N9-120S.pdf
Stav RoHS	 Lead free / RoHS Compliant
Stav zásob	1784 pcs stock
Odeslat z	Hongkong
Cesta zásilky	DHL/Fedex/TNT/UPS/EMS

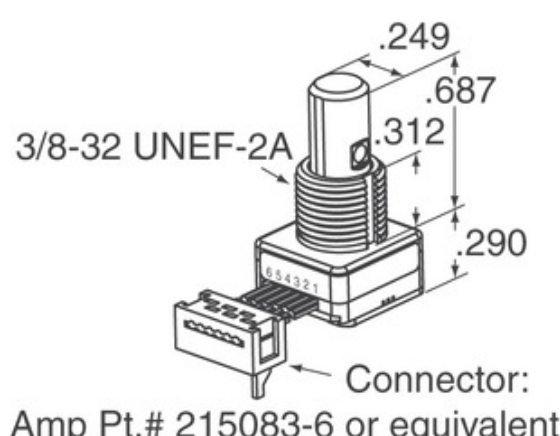
[ŽÁDOST O NABÍDKU](#)

Obraz může být reprezentován. Viz specifikace podrobností o produktu.











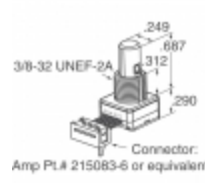

Specifikace 62S11-N9-120S

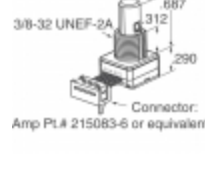
PART NUMBER	62S11-N9-120S
VÝROBCE	Grayhill, Inc.
POPIS	ROTARY ENCODER OPTICAL 32PPR
STAV VOLNÉHO VEDENÍ / ROHS	Lead free / RoHS Compliant
DOSTUPNÉ MNOŽSTVÍ	1784 pcs
DATOVÝ LIST	 62S11-N9-120S.pdf
NAPĚTÍ - SUPPLY	5V
STYL KONCOVKY	Cable Leads
SÉRIE	62S
ROTAČNÍ ŽIVOT (CYKLY MIN)	1M
IMPULZŮ NA OTÁČKU	32
TYP VÝSTUPU	Quadrature (Incremental)
OSTATNÍ JMÉNA	62S11N9120S
ORIENTACE	Vertical
TYP MONTÁŽE	Panel Mount
ÚROVEŇ CITLIVOSTI NA VLHKOST (MSL)	1 (Unlimited)
STAV VOLNÉHO VEDENÍ / ROHS	Lead free / RoHS Compliant
ENCODER TYPE	Optical
ZÁPADKA	No
POSTAVEN V PŘEPÍNAČI	Yes
POHON TYPE	1/4" Dia Flatted End

Související značky

Grayhill, Inc. 62S11-N9-120S	Distributor 62S11-N9-120S	Dodavatel 62S11-N9-120S
62S11-N9-120S Cena	Obrázky 62S11-N9-120S	Obrázek 62S11-N9-120S
Datový list 62S11-N9-120S PDF	62S11-N9-120S Stáhnout datový list	Datový list 62S11-N9-120S
62S11-N9-120S Sklad	Koupit 62S11-N9-120S	Koupit Grayhill, Inc. 62S11-N9-120S
Grayhill, Inc. 62S11-N9-120S	Grayhill, Inc. dodavatel	Distributor Grayhill, Inc.
Grayhill, Inc. 62S11-N9-120S	Grayhill Inc. 62S11-N9-120S	

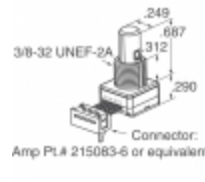
Související produkty

 <p>62S11-N9-060C Výrobci: Grayhill, Inc. Popis: ROTARY ENCODER OPTICAL 32PPR Na skladě: 2192 pcs</p> <p>RFQ</p>	 <p>62S15-H0-040C Výrobci: Grayhill, Inc. Popis: ROTARY ENCODER OPTICAL 24PPR Na skladě: 1793 pcs</p> <p>RFQ</p>
 <p>62S11-N5-100C Výrobci: Grayhill, Inc. Popis: ROTARY ENCODER OPTICAL 32PPR Na skladě: 1789 pcs</p> <p>RFQ</p>	 <p>62S11-N5-120S Výrobci: Grayhill, Inc. Popis: ROTARY ENCODER OPTICAL 32PPR Na skladě: 1675 pcs</p> <p>RFQ</p>
 <p>62S11-N5-P Výrobci: Grayhill, Inc. Popis: ROTARY ENCODER OPTICAL 32PPR Na skladě: 1885 pcs</p> <p>RFQ</p>	 <p>62S11-N5-PV Výrobci: Grayhill, Inc. Popis: ROTARY ENCODER OPTICAL 32PPR Na skladě: 2220 pcs</p> <p>RFQ</p>
 <p>62S15-H0-PH Výrobci: Grayhill, Inc. Popis: ROTARY ENCODER OPTICAL 24PPR Na skladě: 2290 pcs</p> <p>RFQ</p>	 <p>62S15-H0-P Výrobci: Grayhill, Inc. Popis: ROTARY ENCODER OPTICAL 24PPR Na skladě: 2136 pcs</p> <p>RFQ</p>
 <p>62S11-N9-PH Výrobci: Grayhill, Inc. Popis: ROTARY ENCODER OPTICAL 32PPR Na skladě: 2219 pcs</p> <p>RFQ</p>	 <p>62S15-H0-040CH Výrobci: Grayhill, Inc. Popis: ROTARY ENCODER OPTICAL 24PPR Na skladě: 1921 pcs</p> <p>RFQ</p>
 <p>62S11-N9-060SH Výrobci: Grayhill, Inc. Popis: ROTARY ENCODER OPTICAL 32PPR Na skladě: 1801 pcs</p> <p>RFQ</p>	 <p>62S15-H0-020C Výrobci: Grayhill, Inc. Popis: ROTARY ENCODER OPTICAL 24PPR Na skladě: 2286 pcs</p> <p>RFQ</p>

Copyright © 2020 Spolehlivý distributor elektronických komponent

E-mailem: Info@infinity-electronic.com

Adresa: 17F, obchodní dům Gaylord, 114-118 Lockhart Road, Wan Chai, Hongkong

