



Grayhill, Inc.

62S11-N4-P

Part Number:

62S11-N4-P

Výrobce / značka:

Grayhill, Inc.

Popis produktu

ROTARY ENCODER OPTICAL 32PPR

Datasheety:

 62S11-N4-P.pdf

Stav RoHS

 Lead free / RoHS Compliant

Stav zásob

1912 pcs stock

Odeslat z

Hongkong

Cesta zásilky

DHL/Fedex/TNT/UPS/EMS

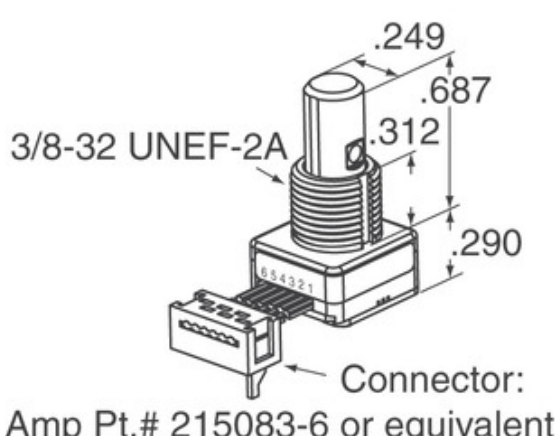
[ŽÁDOST O NABÍDKU](#)

Obraz může být reprezentován. Viz specifikace podrobností o produktu.





Specifikace 62S11-N4-P

PART NUMBER	62S11-N4-P
VÝROBCE	Grayhill, Inc.
POPIS	ROTARY ENCODER OPTICAL 32PPR
STAV VOLNÉHO VEDENÍ / ROHS	Lead free / RoHS Compliant
DOSTUPNÉ MNOŽSTVÍ	1912 pcs
DATOVÝ LIST	 62S11-N4-P.pdf
NAPĚTÍ - SUPPLY	5V
STYL KONCOVKY	PC Pin
SÉRIE	62S
ROTAČNÍ ŽIVOT (CYKLY MIN)	1M
IMPULZŮ NA OTÁČKU	32
TYP VÝSTUPU	Quadrature (Incremental)
OSTATNÍ JMÉNA	62S11N4P
ORIENTACE	Vertical
TYP MONTÁŽE	PCB, Through Hole
ÚROVEŇ CITLIVOSTI NA VLHKOST (MSL)	1 (Unlimited)
STAV VOLNÉHO VEDENÍ / ROHS	Lead free / RoHS Compliant
ENCODER TYPE	Optical
ZÁPADKA	No
POSTAVEN V PŘEPÍNAČI	Yes
POHON TYPE	1/4" Dia Flatted End

Související značky

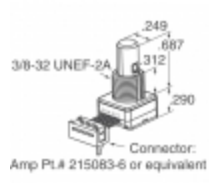
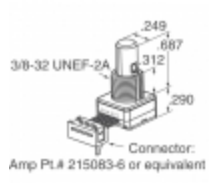
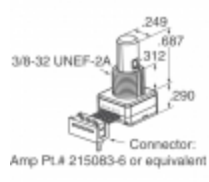
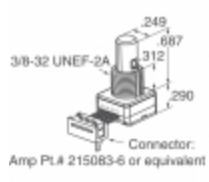
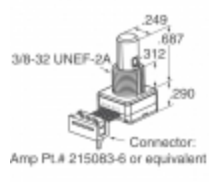
Grayhill, Inc. 62S11-N4-P	Distributor 62S11-N4-P	Dodavatel 62S11-N4-P
62S11-N4-P Cena	Obrázky 62S11-N4-P	Obrázek 62S11-N4-P
Datový list 62S11-N4-P PDF	62S11-N4-P Stáhnout datový list	Datový list 62S11-N4-P
62S11-N4-P Sklad	Koupit 62S11-N4-P	Koupit Grayhill, Inc. 62S11-N4-P
Grayhill, Inc. 62S11-N4-P	Grayhill, Inc. dodavatel	Distributor Grayhill, Inc.
Grayhill, Inc. 62S11-N4-P	Grayhill Inc. 62S11-N4-P	

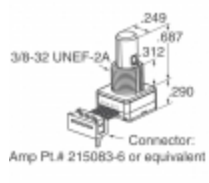
Související produkty

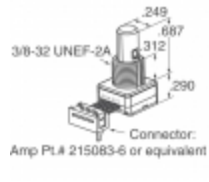
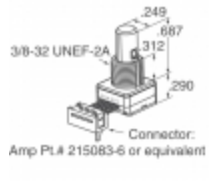
 <p>62S11-N4-025CH Výrobci: Grayhill, Inc. Popis: ROTARY ENCODER OPTICAL 32PPR Na skladě: 1946 pcs</p> <p>RFQ</p>	 <p>62S11-N3-PH Výrobci: Grayhill, Inc. Popis: ROTARY ENCODER OPTICAL 32PPR Na skladě: 1856 pcs</p> <p>RFQ</p>
 <p>62S11-N4-060SH Výrobci: Grayhill, Inc. Popis: ROTARY ENCODER OPTICAL 32PPR Na skladě: 2262 pcs</p> <p>RFQ</p>	 <p>62S11-N4-120S Výrobci: Grayhill, Inc. Popis: ROTARY ENCODER OPTICAL 32PPR Na skladě: 2038 pcs</p> <p>RFQ</p>
 <p>62S11-N5-050C Výrobci: Grayhill, Inc. Popis: ROTARY ENCODER OPTICAL 32PPR Na skladě: 1936 pcs</p> <p>RFQ</p>	 <p>62S11-N4-020C Výrobci: Grayhill, Inc. Popis: ROTARY ENCODER OPTICAL 32PPR Na skladě: 2083 pcs</p> <p>RFQ</p>
 <p>62S11-N5-025C Výrobci: Grayhill, Inc. Popis: ROTARY ENCODER OPTICAL 32PPR Na skladě: 2408 pcs</p> <p>RFQ</p>	 <p>62S11-N5-040C Výrobci: Grayhill, Inc. Popis: ROTARY ENCODER OPTICAL 32PPR Na skladě: 2106 pcs</p> <p>RFQ</p>
 <p>62S11-N4-025C Výrobci: Grayhill, Inc. Popis: ROTARY ENCODER OPTICAL 32PPR Na skladě: 1970 pcs</p> <p>RFQ</p>	 <p>62S11-N5-025CH Výrobci: Grayhill, Inc. Popis: ROTARY ENCODER OPTICAL 32PPR Na skladě: 2083 pcs</p> <p>RFQ</p>
 <p>62S11-N4-PH Výrobci: Grayhill, Inc. Popis: ROTARY ENCODER OPTICAL 32PPR Na skladě: 1970 pcs</p> <p>RFQ</p>	 <p>62S11-N5-060C Výrobci: Grayhill, Inc. Popis: ROTARY ENCODER OPTICAL 32PPR Na skladě: 2164 pcs</p> <p>RFQ</p>

Copyright © 2020 Spolehlivý distributor elektronických komponent

E-mailem: Info@infinity-electronic.com

Adresa: 17F, obchodní dům Gaylord, 114-118 Lockhart Road, Wan Chai, Hongkong

